

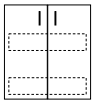

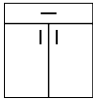







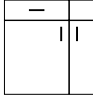

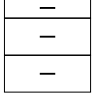
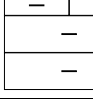
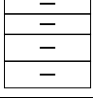
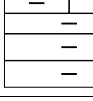

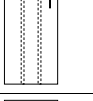
ADA Cabinets (28 1/2"High x 24"Deep)

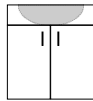
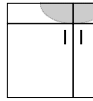
<i>Item</i>	<i>Name</i>	<i>Page</i>
	AU	2
	AU/RO	3
	ATD	4
	ATD/RO	5
	A2TD	6
	A2TD/RO	7
	A3D	8
	A3D/2TD	9
	A4D	10
	A4D/2TD	11
	AMD	12
	AU/Tray	13
	ATD/Tray	14

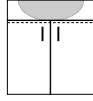
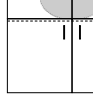
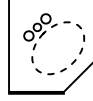
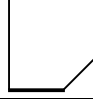
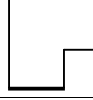
<i>Item</i>	<i>Name</i>	<i>Page</i>
	ASU	15
	ASFF	16
	AS2FF	17
	ASU/Apron	18
	ASFF/Apron	19
	AS2FF/Apron	20
	ASFF/45C	21
	AU/45C	22
	AU/90C	23
	AU/BCL	24
	AU/BCR	25
	ATD/BCL	26
	ATD/BCR	27

ADA Unit
1 - Adjustable Shelf (AS)

AU

Specify Single Door Cabinets as **HL** or **HR**

Doors, Drawer Fronts & Hardware Not Included In Catalog Price

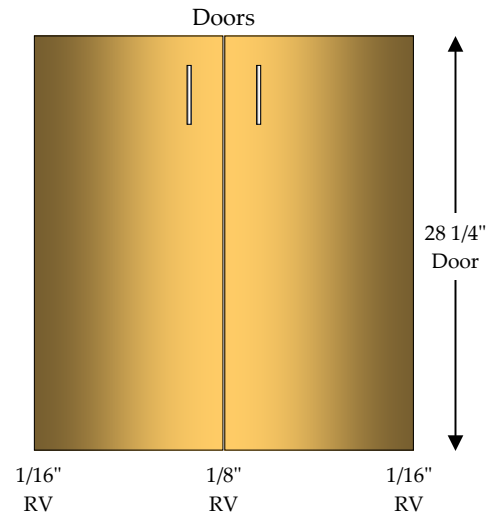
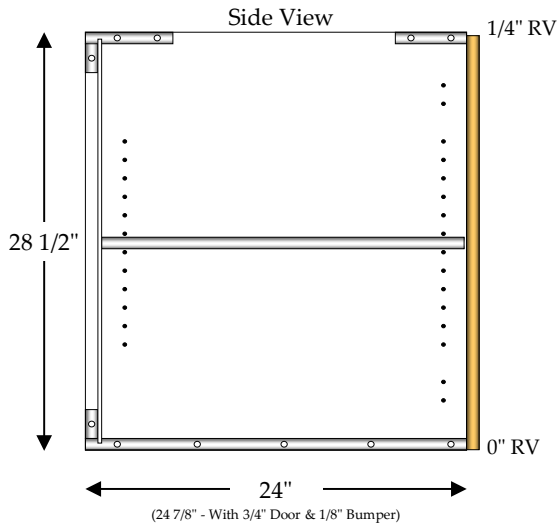

ADA Unit / Roll Out

2 - 4" Roll Outs (RO)

Roll Outs include 1" spacer blocks

Specify Single Door Cabinets as **HL** or **HR**

Doors, Drawer Fronts & Hardware Not Included In Catalog Price

AU/RO

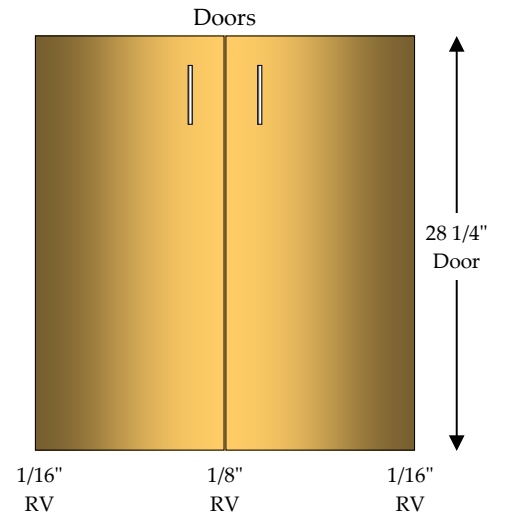
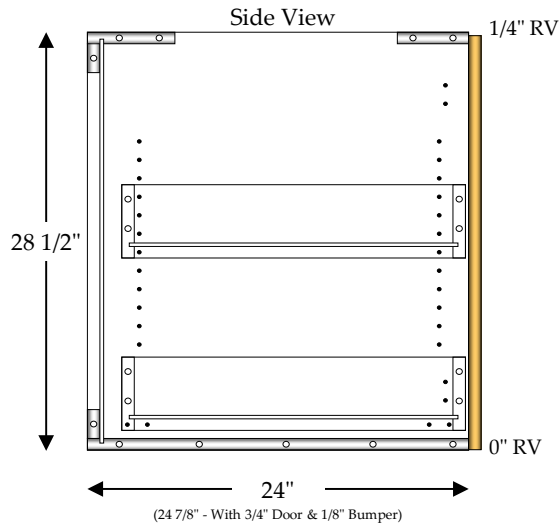

585 North 700 West Suit A-B, North Salt Lake, UT 84054

Email: acc@alphacabinets.com

<http://www.alphacabinets.com>

Phone: 801-295-9417

Fax: 801-292-2762

[Return to ADA Menu](#)

ADA Top Drawer

1 - 4" Drawer (DRW)

1 - Adjustable Shelf (AS)

Specify Single Door Cabinets as **HL** or **HR**

Doors, Drawer Fronts & Hardware Not Included In Catalog Price

ATD

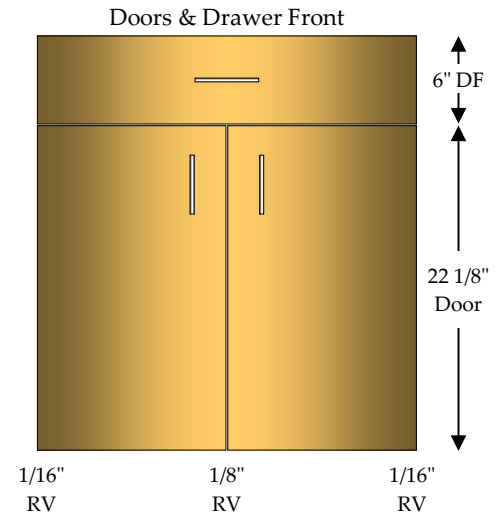
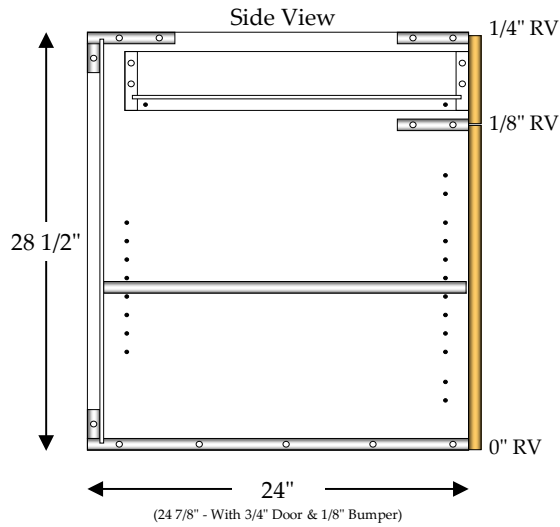

ADA Top Drawer / Roll Out

1 - 4" Drawer (DRW)

2 - 4" Roll Outs (RO)

Roll Outs include 1" spacer blocks

Specify Single Door Cabinets as **HL** or **HR**

Doors, Drawer Fronts & Hardware Not Included In Catalog Price

ATD/RO

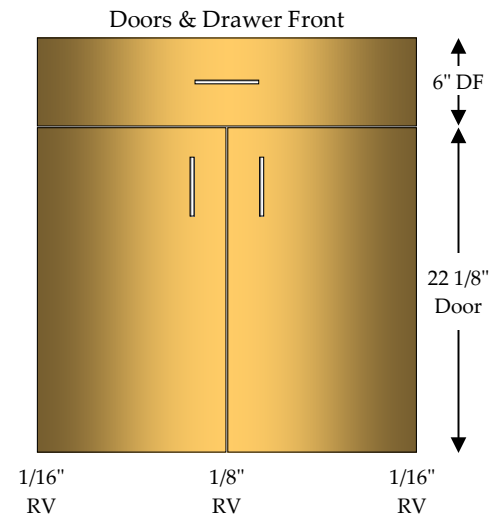
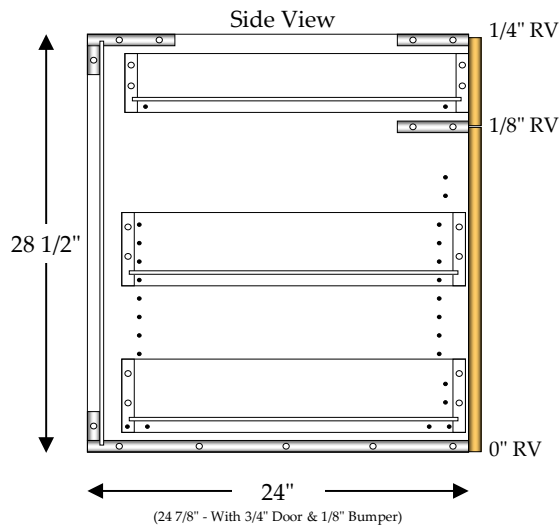

585 North 700 West Suit A-B, North Salt Lake, UT 84054

Email: acc@alphacabinets.com

<http://www.alphacabinets.com>

Phone: 801-295-9417

Fax: 801-292-2762

[Return to ADA Menu](#)

ADA 2 Top Drawer

2 - 4" Top Drawers (2TD)

1 - Adjustable Shelf (AS)

Full Top, Double Partition Between Top Drawers

Specify Single Door Cabinets as **HL** or **HR**

Doors, Drawer Fronts & Hardware Not Included In Catalog Price

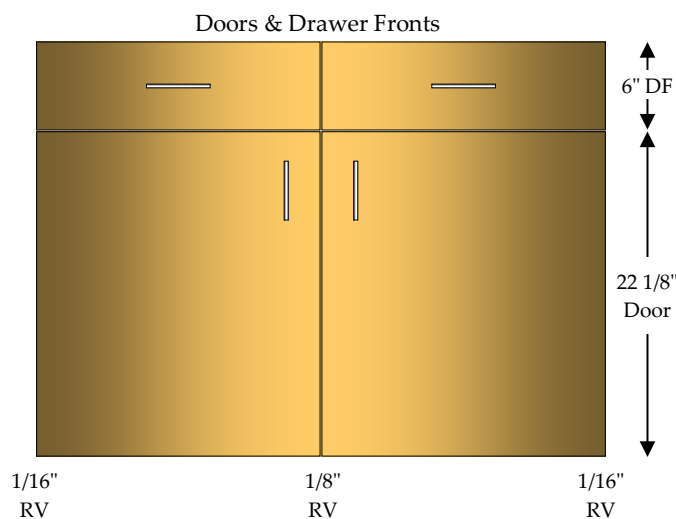
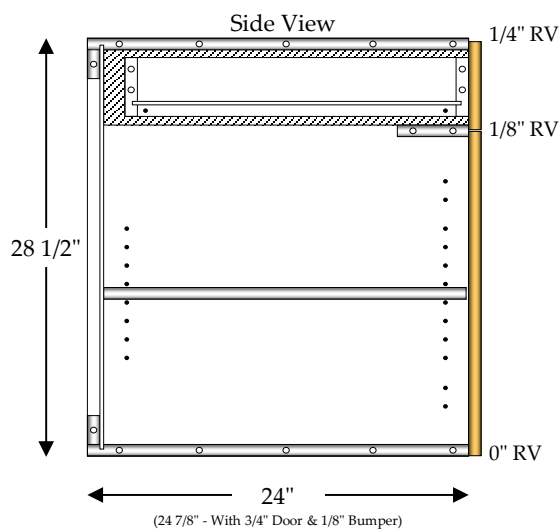

ADA 2 Top Drawer / Roll Out

2 - 4" Top Drawers (2TD)

2 - 4" Roll Outs (RO)

Full Top, Double Partition Between Top Drawers

Roll Outs include 1" spacer blocks

Specify Single Door Cabinets as **HL** or **HR**

Doors, Drawer Fronts & Hardware Not Included In Catalog Price

A2TD/RO

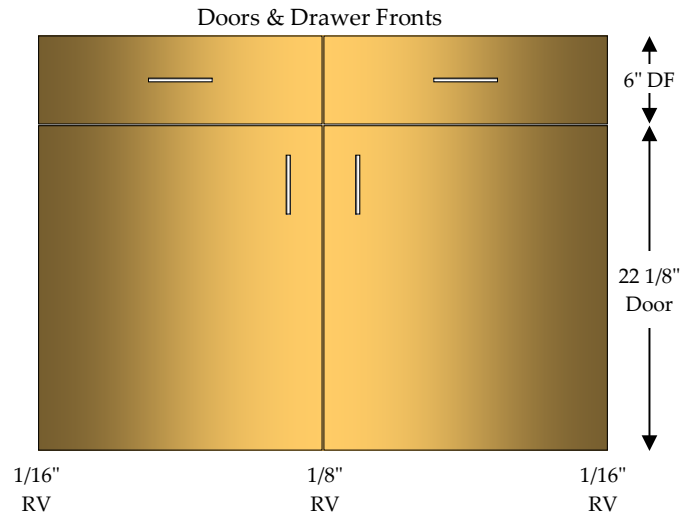
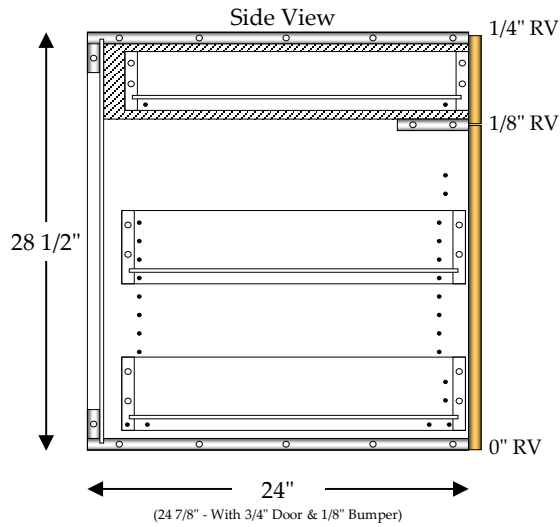

585 North 700 West Suit A-B, North Salt Lake, UT 84054

Email: acc@alphacabinets.com

<http://www.alphacabinets.com>

Phone: 801-295-9417

Fax: 801-292-2762

[Return to ADA Menu](#)

Base 3 Drawer

1 - 4" Drawer (DRW)

2 - 9" Drawers (DRW)

Doors, Drawer Fronts & Hardware Not Included In Catalog Price

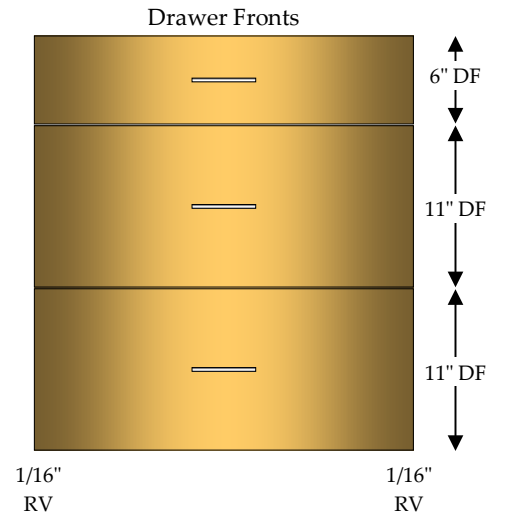
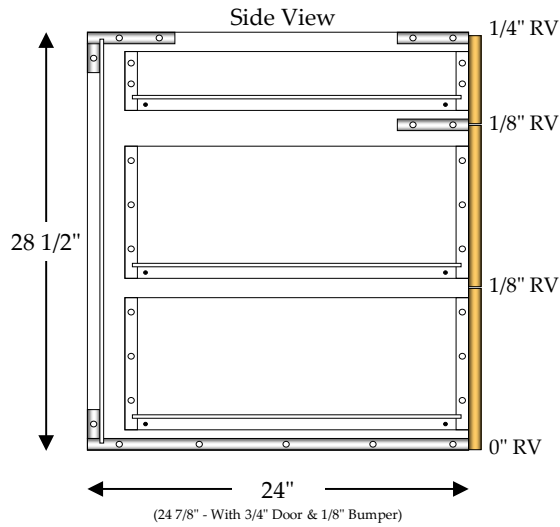

ADA 3 Drawer / 2 Top Drawer

2 - 4" Top Drawers (2TD)

2 - 9" Drawers (DRW)

A3D/2TD

Full Top, Double Partition Between Top Drawers

Doors, Drawer Fronts & Hardware Not Included In Catalog Price

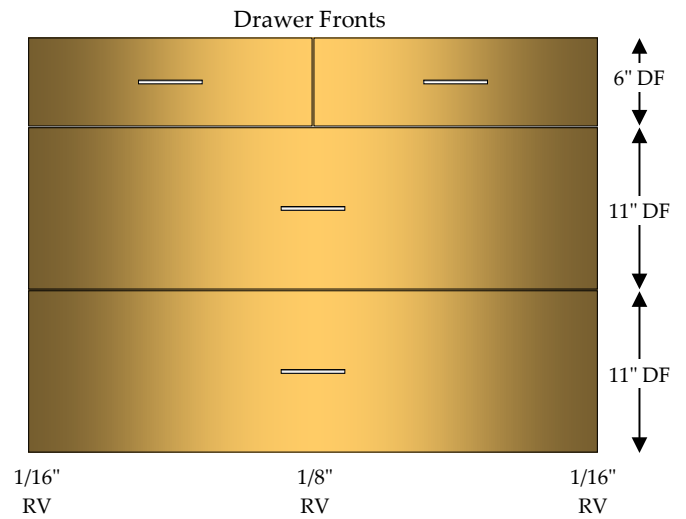
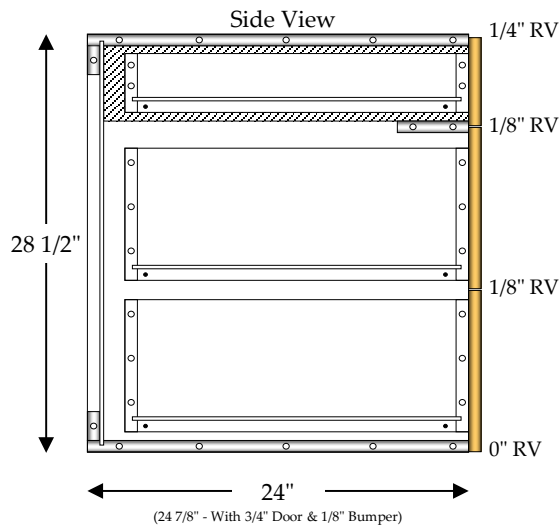

585 North 700 West Suit A-B, North Salt Lake, UT 84054

Email: acc@alphacabinets.com

<http://www.alphacabinets.com>

Phone: 801-295-9417

Fax: 801-292-2762

[Return to ADA Menu](#)

ADA 4 Drawer

2 - 4" Drawer (DRW)

2 - 6" Drawers (DRW)

A4D

Doors, Drawer Fronts & Hardware Not Included In Catalog Price

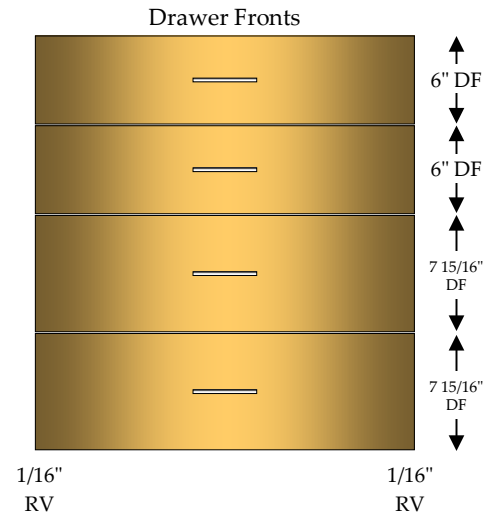
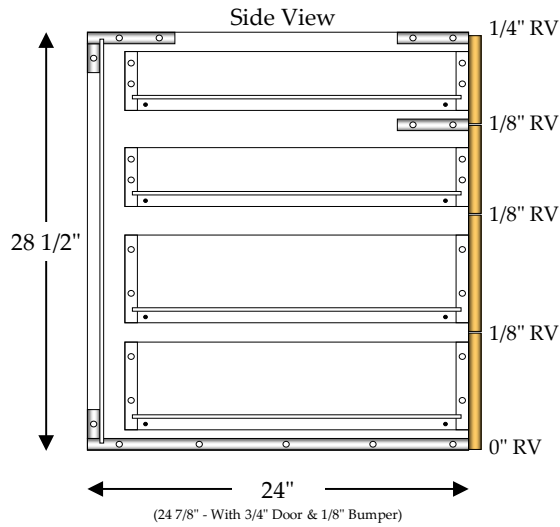

ADA 4 Drawer / 2 Top Drawer

2 - 4" Top Drawers (2TD)

1 - 4" Drawer (DRW)

2 - 6" Drawers (DRW)

Full Top, Double Partition Between Top Drawers

Doors, Drawer Fronts & Hardware Not Included In Catalog Price

A4D/2TD

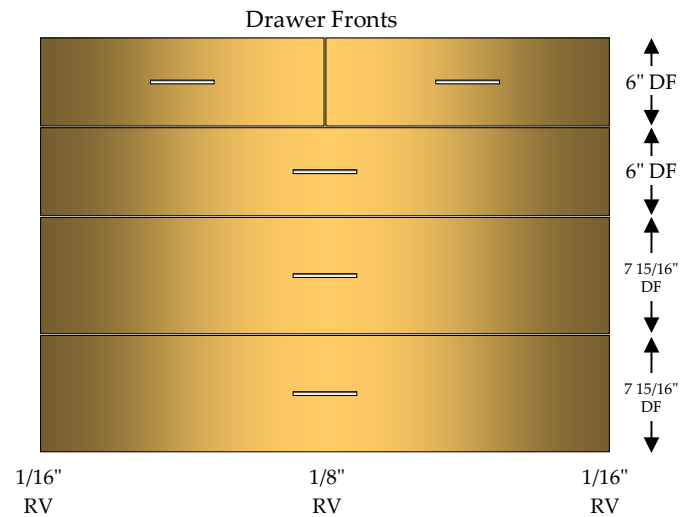
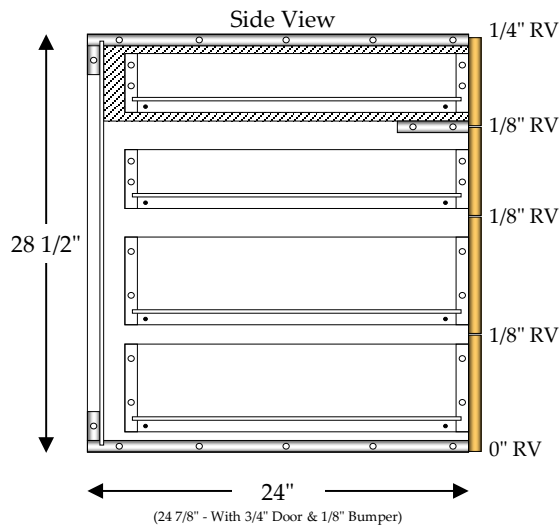

ADA Microwave Drawer

1 - 9" Drawer (DRW)

1 - Fixed Shelf (FS)

Specify Microwave Opening for FS Placement
Specify Drawer Front Overlay on FS for DF Size

Doors, Drawer Fronts & Hardware Not Included In Catalog Price

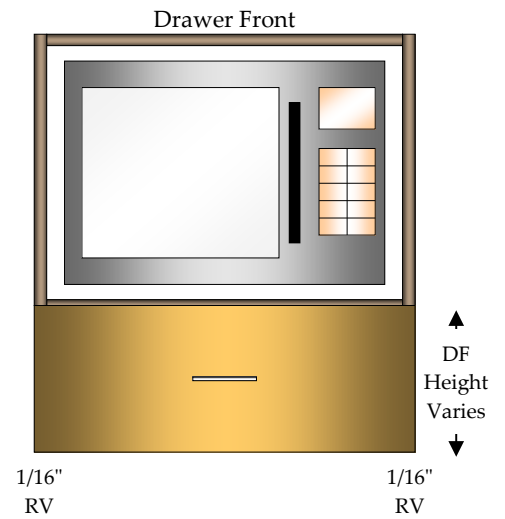
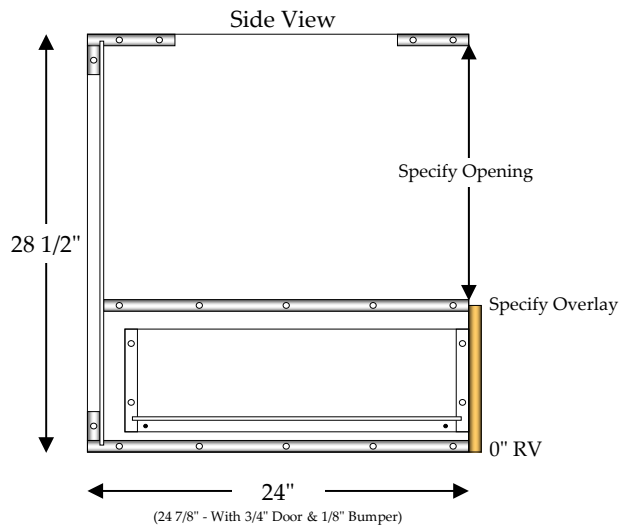

ADA Unit / Tray

3/4" Partitions (1/4" Partitions with Dado Upon Request)

Full Top

Specify Single Door Cabinets as **HL** or **HR**

Doors, Drawer Fronts & Hardware Not Included In Catalog Price

AU/Tray

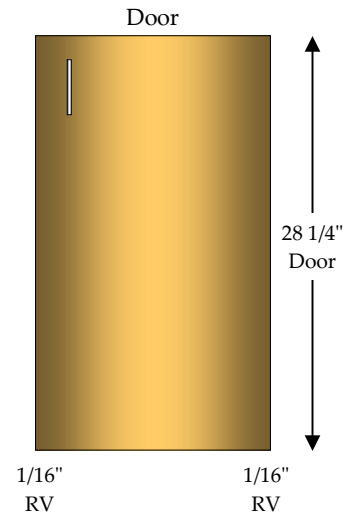
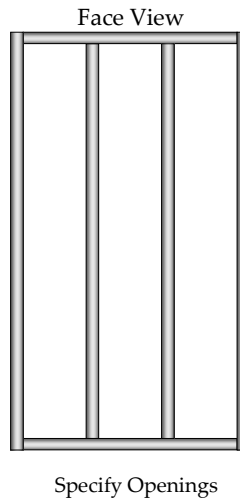
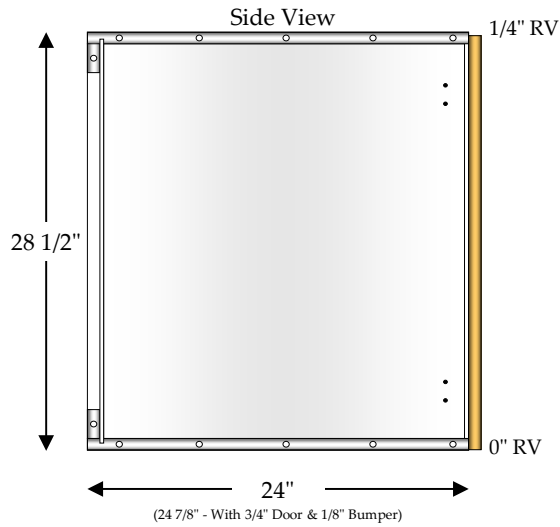

ADA Top Drawer / Tray

1 - 4" Drawer (DRW)

3/4" Partitions (1/4" Partitions with Dado Upon Request)

1 - Fixed Shelf (FS)

Specify Single Door Cabinets as **HL** or **HR**

Doors, Drawer Fronts & Hardware Not Included In Catalog Price

ATD/Tray

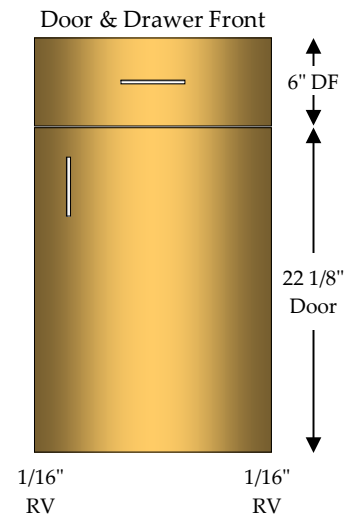
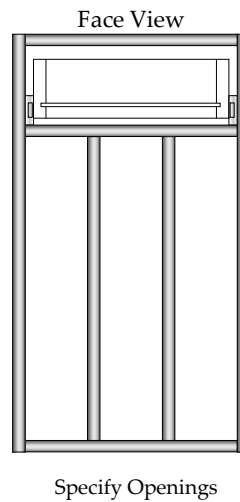
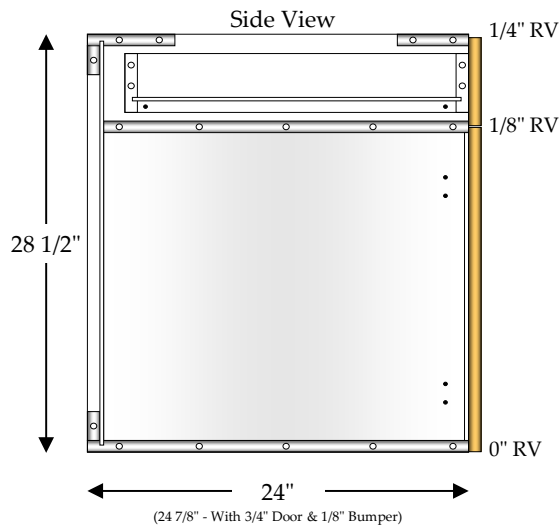

ADA Sink Unit

ASU

Specify Single Door Cabinets as **HL** or **HR**

Doors, Drawer Fronts & Hardware Not Included In Catalog Price

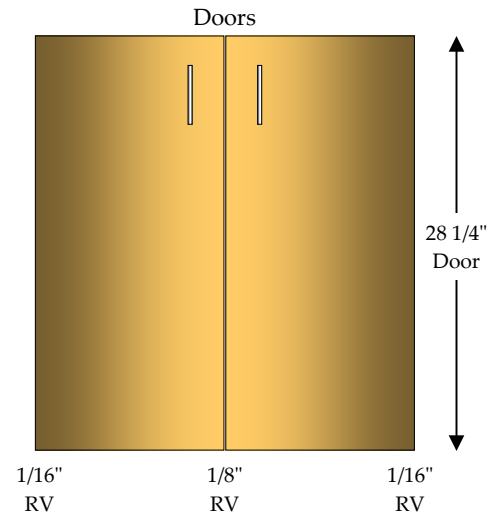
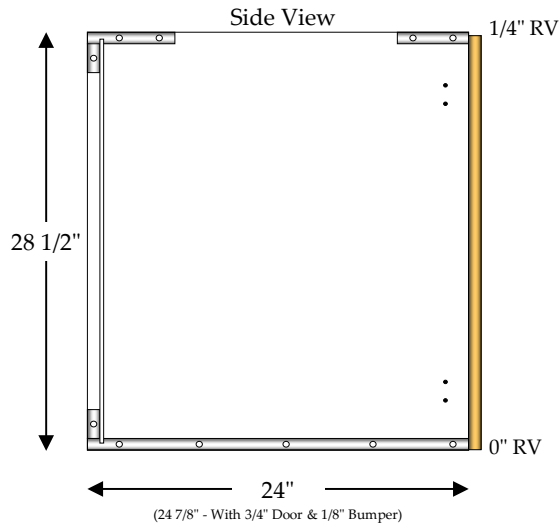

ADA Sink False Front

2 - Particle Board Blocks to Mount False Front

Specify Single Door Cabinets as **HL** or **HR**

Doors, Drawer Fronts & Hardware Not Included In Catalog Price

ASFF

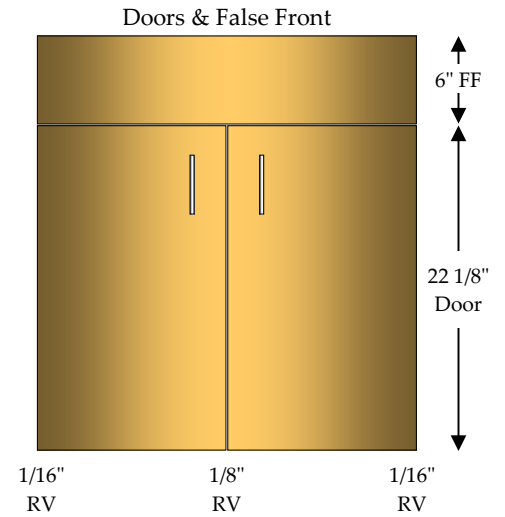
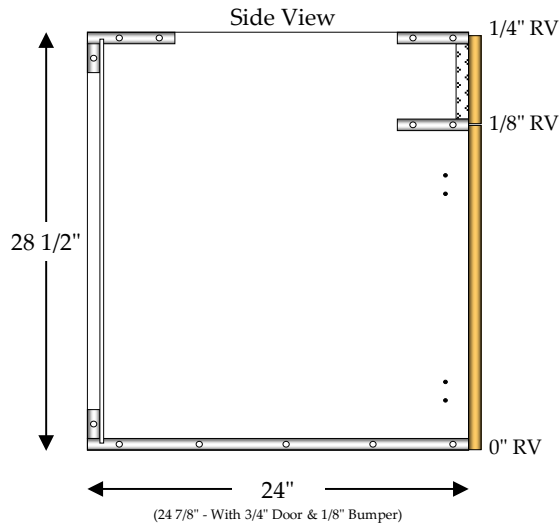

585 North 700 West Suit A-B, North Salt Lake, UT 84054

Email: acc@alphacabinets.com
<http://www.alphacabinets.com>

Phone: 801-295-9417
Fax: 801-292-2762

[Return to ADA Menu](#)

ADA Sink 2 False Front

AS2FF

Double Partition Between False Fronts
4 - Particle Board Blocks to Mount False Front

Specify Single Door Cabinets as **HL** or **HR**

Doors, Drawer Fronts & Hardware Not Included In Catalog Price

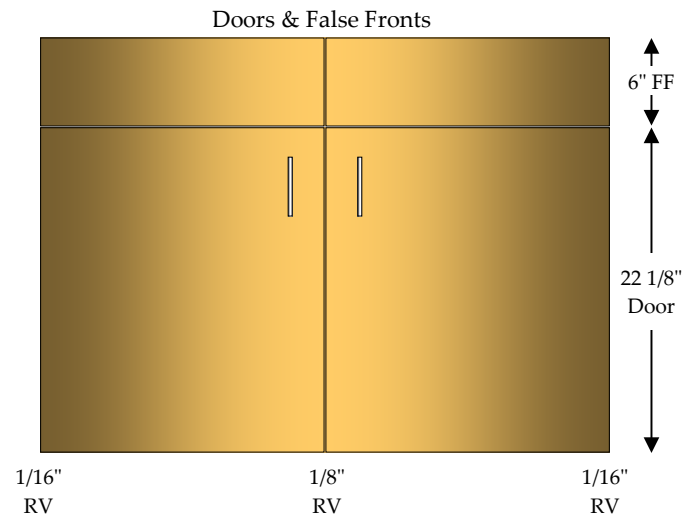
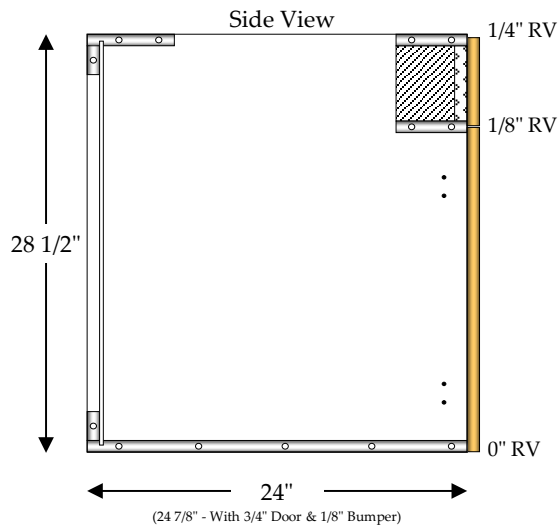

585 North 700 West Suit A-B, North Salt Lake, UT 84054

Email: acc@alphacabinets.com
<http://www.alphacabinets.com>

Phone: 801-295-9417
Fax: 801-292-2762

[Return to ADA Menu](#)

ADA Sink Unit Apron

1 - 7" Apron (Box material unless otherwise specified)
Top Hinge (Bore Doors 9" on Center)

Specify Single Door Cabinets as **HL** or **HR**

Doors, Drawer Fronts & Hardware Not Included In Catalog Price

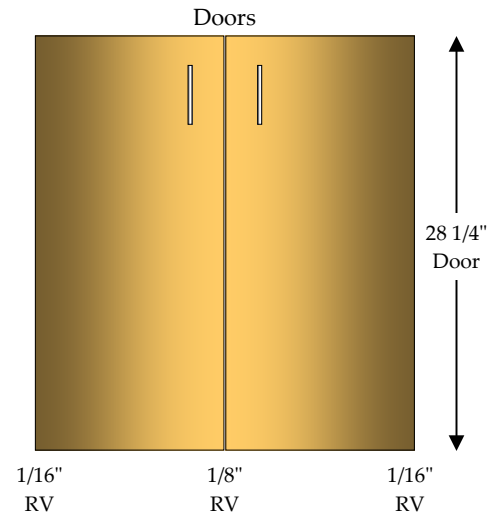
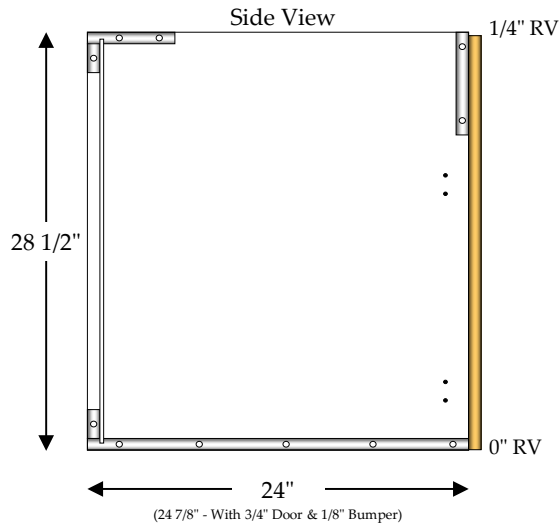

585 North 700 West Suit A-B, North Salt Lake, UT 84054

Email: acc@alphacabinets.com
<http://www.alphacabinets.com>

Phone: 801-295-9417
Fax: 801-292-2762

[Return to ADA Menu](#)

ADA Sink False Front Apron

1 - 7" Apron (Box material unless otherwise specified)

Specify Single Door Cabinets as **HL** or **HR**

Doors, Drawer Fronts & Hardware Not Included In Catalog Price

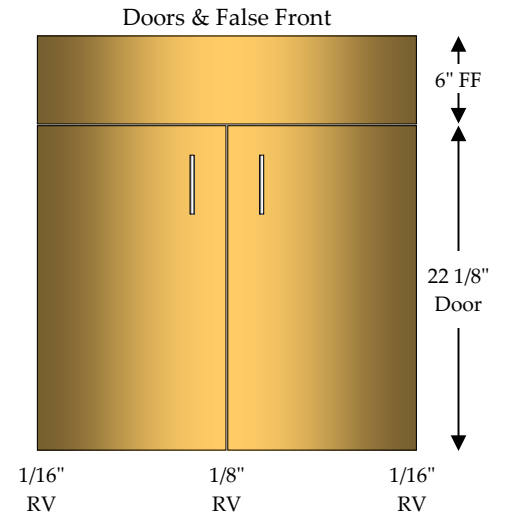
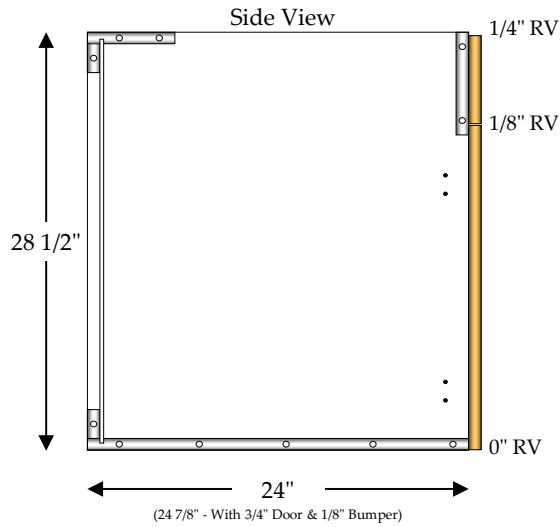

585 North 700 West Suit A-B, North Salt Lake, UT 84054

Email: acc@alphacabinets.com

<http://www.alphacabinets.com>

Phone: 801-295-9417

Fax: 801-292-2762

[Return to ADA Menu](#)

ADA Sink 2 False Front Apron

1 - 7" Apron (Box material unless otherwise specified)

Specify Single Door Cabinets as **HL** or **HR**

Doors, Drawer Fronts & Hardware Not Included In Catalog Price

AS2FF/Apron

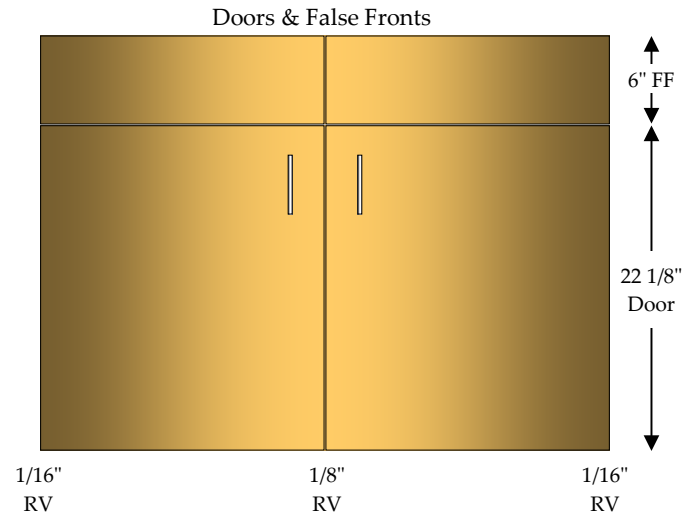
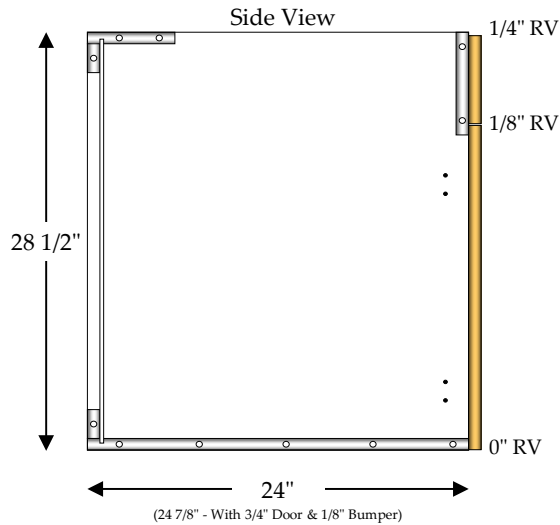

585 North 700 West Suit A-B, North Salt Lake, UT 84054

Email: acc@alphacabinets.com

<http://www.alphacabinets.com>

Phone: 801-295-9417

Fax: 801-292-2762

[Return to ADA Menu](#)

ADA Sink False Front / 45° Corner

ASFF/45C

2 - Particle Board Blocks to Mount False Front
Mid Spreader requires customer placement

Specify Single Door Cabinets as **HL** or **HR**

Doors, Drawer Fronts & Hardware Not Included In Catalog Price

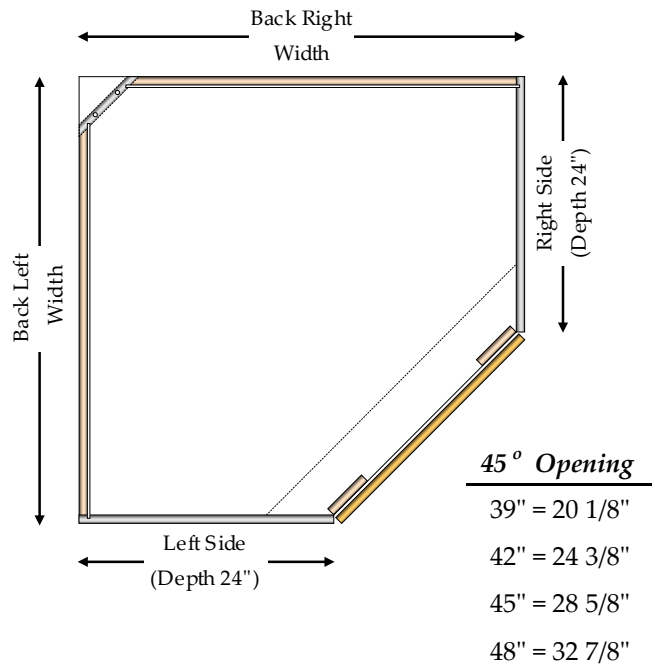
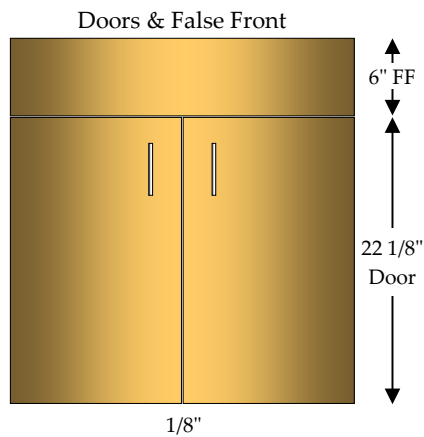
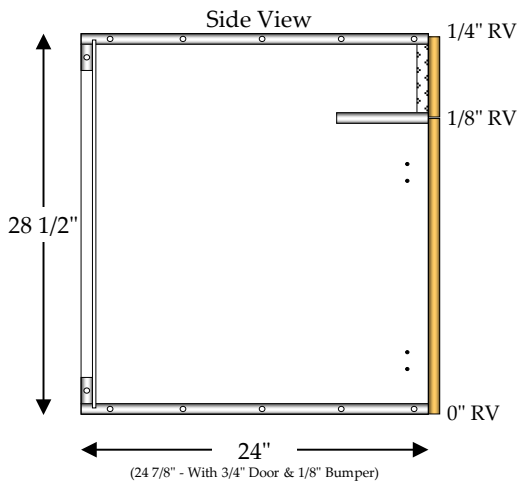

Warning!

Door width may need to be adjusted depending on door edge profile.

ADA Unit / 45° Corner
1 - Adjustable Shelf (AS)

AU/45C

Specify Single Door Cabinets as **HL** or **HR**

Doors, Drawer Fronts & Hardware Not Included In Catalog Price

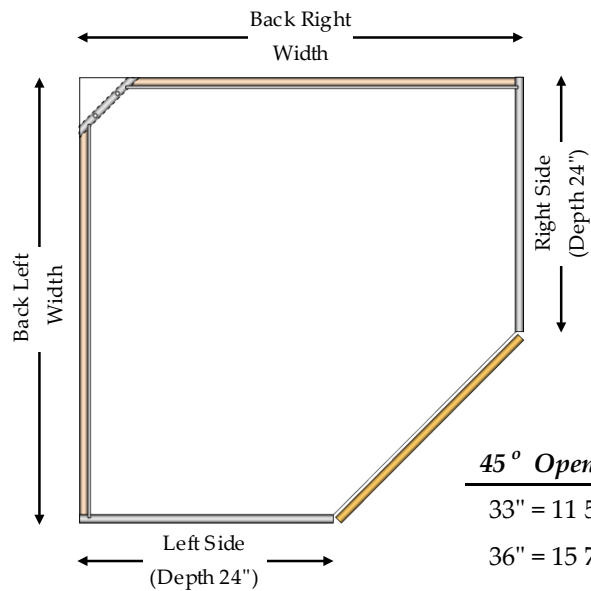
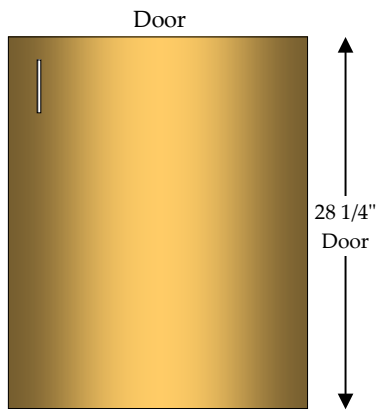
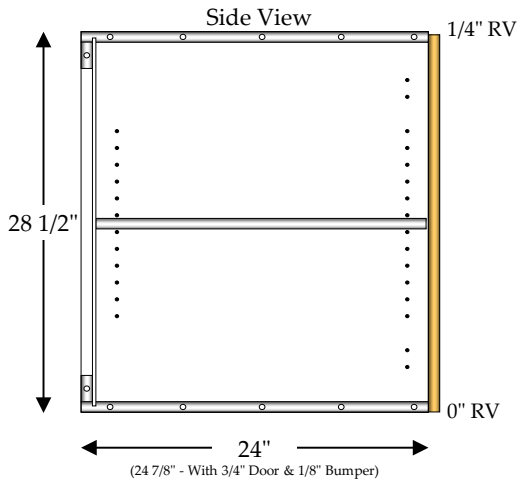

<u>45° Opening</u>	
33"	= 11 5/8"
36"	= 15 7/8"
39"	= 20 1/8"
42"	= 24 3/8"
45"	= 28 5/8"
48"	= 32 7/8"

Warning!

Door width may need to be adjusted depending on door edge profile.

ADA Unit / 90° Corner
1 - Adjustable Shelf (AS)

AU/90C

Specify Single Door Cabinets as **HL** or **HR**

Doors, Drawer Fronts & Hardware Not Included In Catalog Price

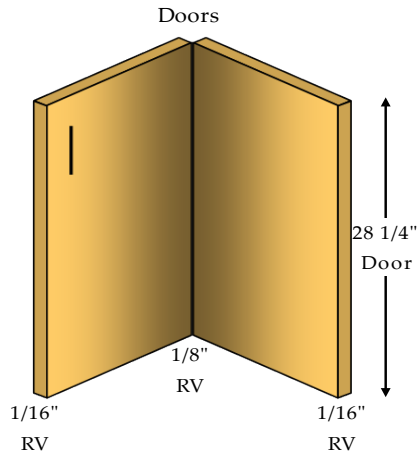
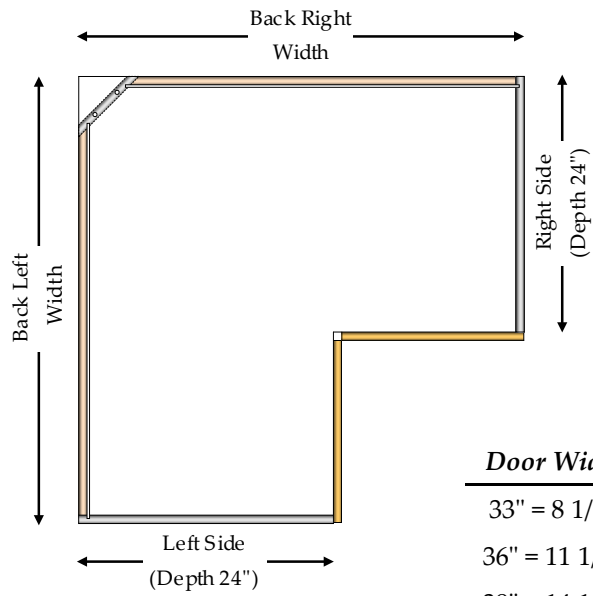
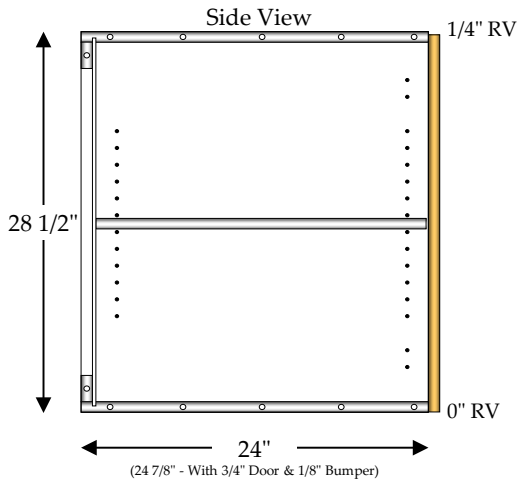

Door Width

- 33" = 8 1/16"
- 36" = 11 1/16"
- 39" = 14 1/16"
- 42" = 17 1/16"
- 45" = 20 1/16"
- 48" = 23 1/16"

ADA Unit / Blind Corner Left

1 - Adjustable Shelf (AS)

1 - 27" Blind Panel (Box material unless otherwise specified)

Specify Single Door Cabinets as **HL** or **HR**

Doors, Drawer Fronts & Hardware Not Included In Catalog Price

AU/BCL

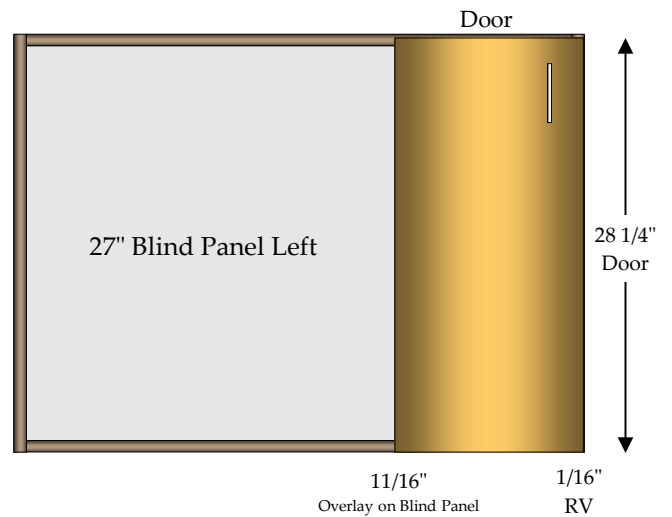
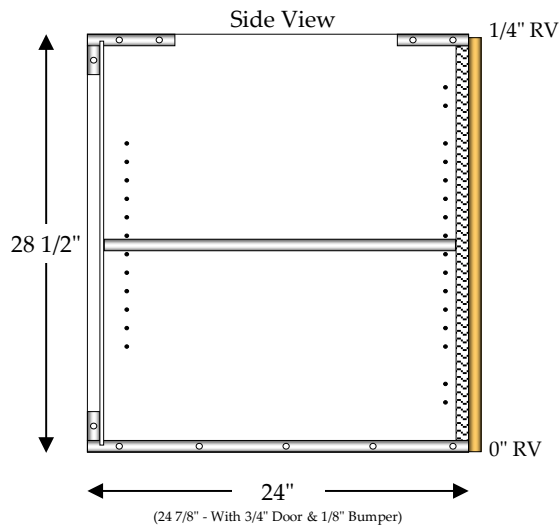

585 North 700 West Suit A-B, North Salt Lake, UT 84054

Email: acc@alphacabinets.com

<http://www.alphacabinets.com>

Phone: 801-295-9417

Fax: 801-292-2762

[Return to ADA Menu](#)

ADA Unit / Blind Corner Right

1 - Adjustable Shelf (AS)

1 - 27" Blind Panel (Box material unless otherwise specified)

Specify Single Door Cabinets as **HL** or **HR**

Doors, Drawer Fronts & Hardware Not Included In Catalog Price

AU/BCR

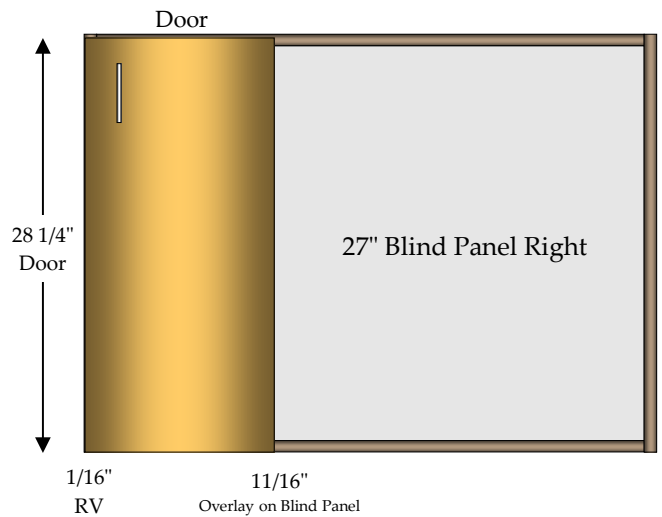
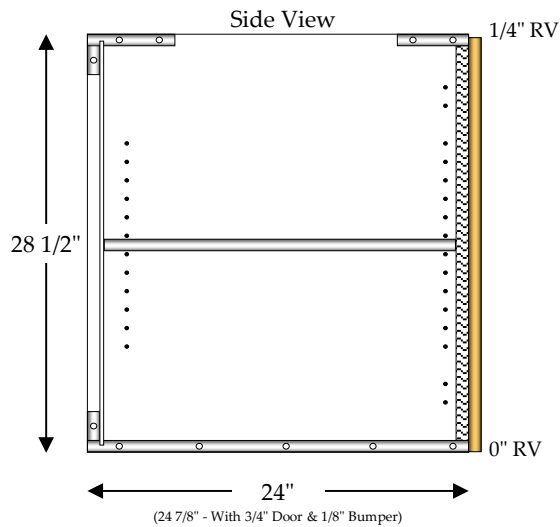

585 North 700 West Suit A-B, North Salt Lake, UT 84054

Email: acc@alphacabinets.com

<http://www.alphacabinets.com>

Phone: 801-295-9417

Fax: 801-292-2762

[Return to ADA Menu](#)

ADA Top Drawer / Blind Corner Left

1 - 4" Drawer (DRW)

1 - Adjustable Shelf (AS)

1 - 27" Blind Panel (Box material unless otherwise specified)

Specify Single Door Cabinets as **HL** or **HR**

Doors, Drawer Fronts & Hardware Not Included In Catalog Price

ATD/BCL

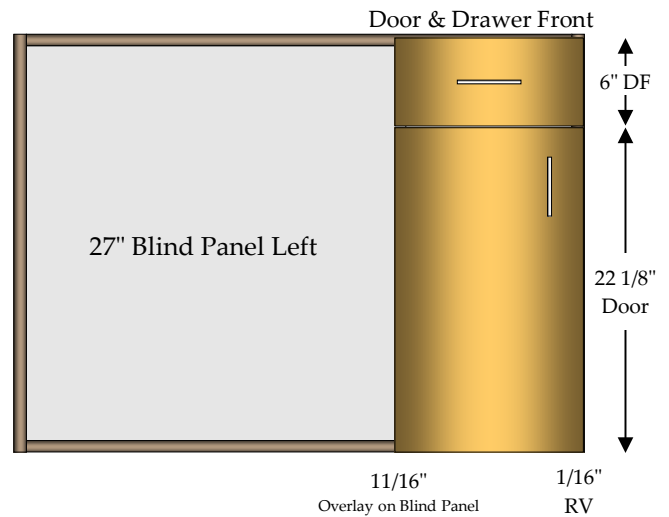
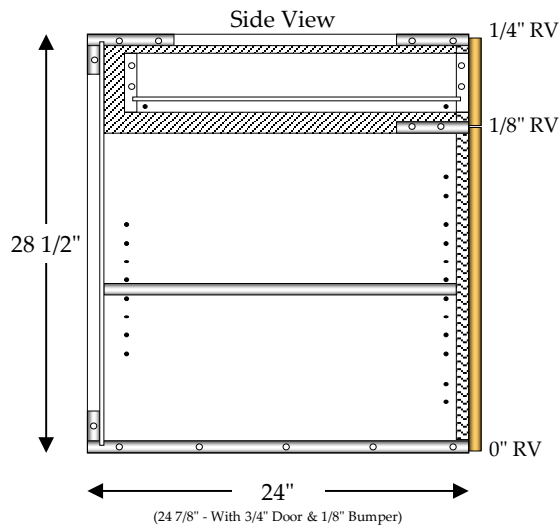

ADA Top Drawer / Blind Corner Right

1 - 4" Drawer (DRW)

1 - Adjustable Shelf (AS)

1 - 27" Blind Panel (Box material unless otherwise specified)

Specify Single Door Cabinets as **HL** or **HR**

Doors, Drawer Fronts & Hardware Not Included In Catalog Price

ATD/BCR

