

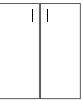

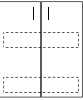

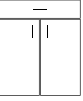





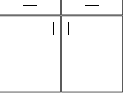
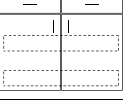

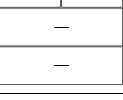
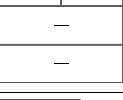
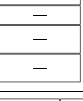
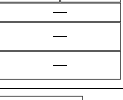
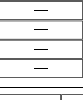
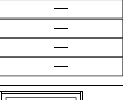

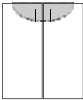
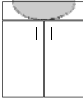
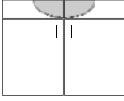

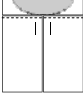
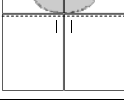
Base Cabinets (30 1/2" High x 24" Deep)

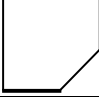
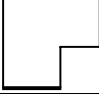
| Item | Name | Page |
|---|----------|------|
|  | BU | B2 |
|  | BU/RO | B3 |
|  | BTD | B4 |
|  | BTD/RO | B5 |
|  | B2TD | B6 |
|  | B2TD/RO | B7 |
|  | B3D | B8 |
|  | B3DF | B9 |
|  | B3D/2TD | B10 |
|  | B3DF/2TD | B11 |
|  | B4D | B12 |
|  | B4D/2TD | B13 |
|  | B5D | B14 |
|  | B5D/2TD | B15 |
|  | BMD | B16 |

| Item | Name | Page |
|--|----------|------|
|  | BSU | B17 |
|  | BSFF | B18 |
|  | BS2FF | B19 |
|  | BSUA | B20 |
|  | BSFFA | B21 |
|  | BS2FFA | B22 |
|  | BSFF/45C | B23 |
|  | BU/45C | B24 |
|  | BU/90C | B25 |
|  | BU/BCL | B26 |
|  | BU/BCR | B27 |
|  | BTD/BCL | B28 |
|  | BTD/BCR | B29 |
|  | BU/Tray | B30 |
|  | BTD/Tray | B31 |

Base Unit
1 - Adjustable Shelf (AS)

Specify Single Door Cabinets as **HL** or **HR**

Doors, Drawer Fronts & Hardware Not Included In Catalog Price

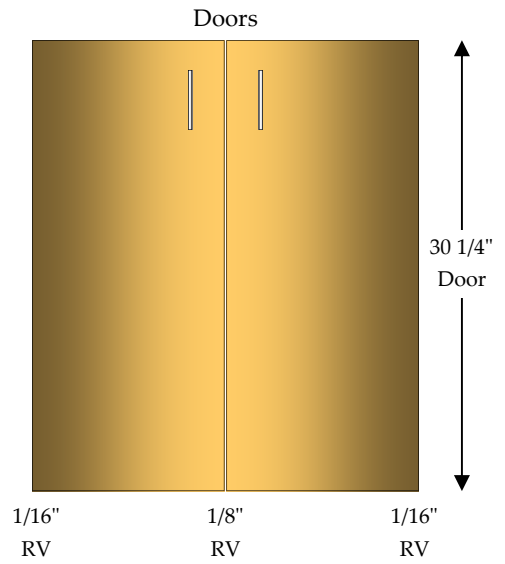
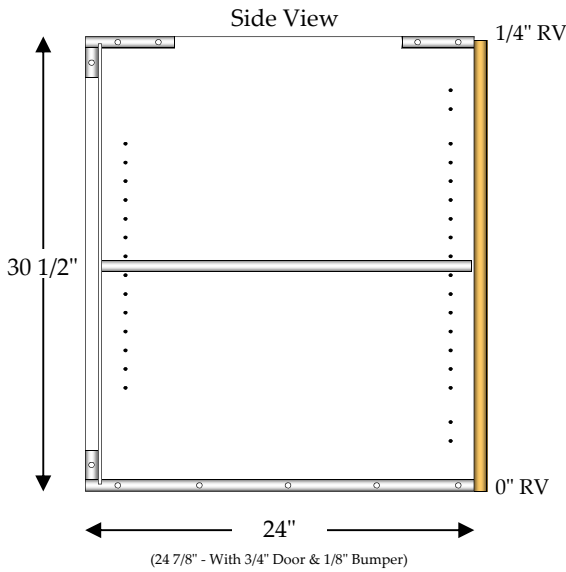

Extrinsic Parts

| Width | BU |
|-------|-----------|
| 9" | \$44.32 |
| 12" | \$47.56 |
| 15" | \$50.80 |
| 18" | \$54.04 |
| 21" | \$57.28 |
| 24" | \$60.51 |
| 27" | \$63.75 |
| 30" | \$66.99 |
| 33" | \$70.23 |
| 36" | \$73.47 |
| 39" | \$76.71 |
| 42" | \$79.94 |
| 45" | \$83.18 |
| 48" | \$86.42 |

| Box Only | AS | 5" RO |
|-----------------|-----------|--------------|
| \$40.38 | \$3.94 | \$12.08 |
| \$42.63 | \$4.93 | \$12.98 |
| \$44.88 | \$5.92 | \$13.88 |
| \$47.13 | \$6.91 | \$14.78 |
| \$49.38 | \$7.90 | \$15.68 |
| \$51.63 | \$8.88 | \$16.59 |
| \$53.88 | \$9.87 | \$17.49 |
| \$56.13 | \$10.86 | \$18.39 |
| \$58.38 | \$11.85 | \$19.29 |
| \$60.63 | \$12.84 | \$20.19 |
| \$62.88 | \$13.83 | \$21.09 |
| \$65.13 | \$14.81 | \$22.00 |
| \$67.38 | \$15.80 | \$22.90 |
| \$69.63 | \$16.79 | \$23.80 |

Base Unit / Roll Out

2 - 5" Roll Outs (RO)

Roll Outs include spacer blocks on both sides
(Spacer blocks on a single side upon request)

Specify Single Door Cabinets as **HL** or **HR**

Doors, Drawer Fronts & Hardware Not Included In Catalog Price

BU/RO

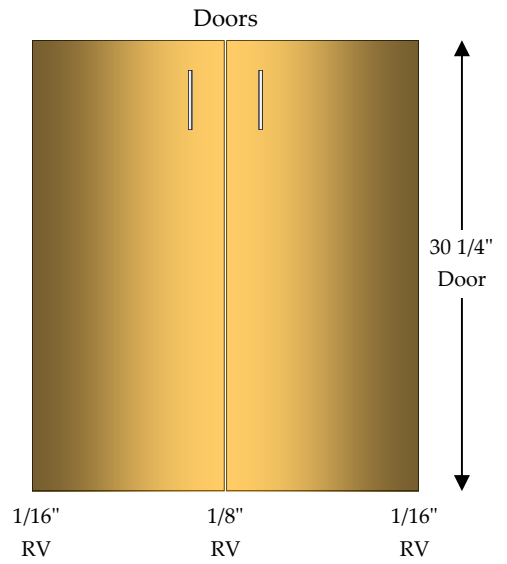
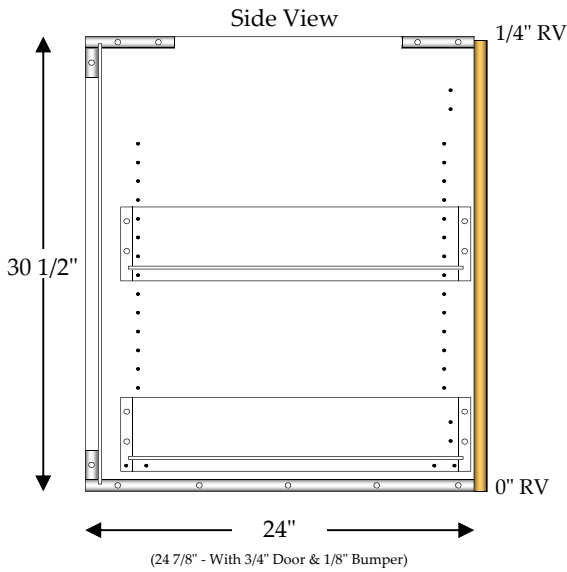

Extrinsic Parts

| Width | BU/RO |
|-------|----------|
| 9" | \$64.54 |
| 12" | \$68.59 |
| 15" | \$72.65 |
| 18" | \$76.70 |
| 21" | \$80.75 |
| 24" | \$84.81 |
| 27" | \$88.86 |
| 30" | \$92.91 |
| 33" | \$96.97 |
| 36" | \$101.02 |
| 39" | \$105.07 |
| 42" | \$109.13 |
| 45" | \$113.18 |
| 48" | \$117.23 |

| Box Only | AS | 5" RO |
|----------|---------|---------|
| \$40.38 | \$3.94 | \$12.08 |
| \$42.63 | \$4.93 | \$12.98 |
| \$44.88 | \$5.92 | \$13.88 |
| \$47.13 | \$6.91 | \$14.78 |
| \$49.38 | \$7.90 | \$15.68 |
| \$51.63 | \$8.88 | \$16.59 |
| \$53.88 | \$9.87 | \$17.49 |
| \$56.13 | \$10.86 | \$18.39 |
| \$58.38 | \$11.85 | \$19.29 |
| \$60.63 | \$12.84 | \$20.19 |
| \$62.88 | \$13.83 | \$21.09 |
| \$65.13 | \$14.81 | \$22.00 |
| \$67.38 | \$15.80 | \$22.90 |
| \$69.63 | \$16.79 | \$23.80 |

Base Top Drawer

- 1 - 4" Drawer (DRW)**
- 1 - Adjustable Shelf (AS)**

Specify Single Door Cabinets as **HL** or **HR**

Doors, Drawer Fronts & Hardware Not Included In Catalog Price

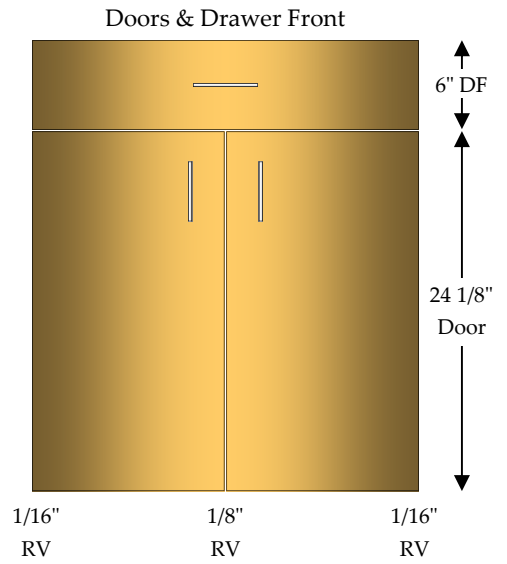
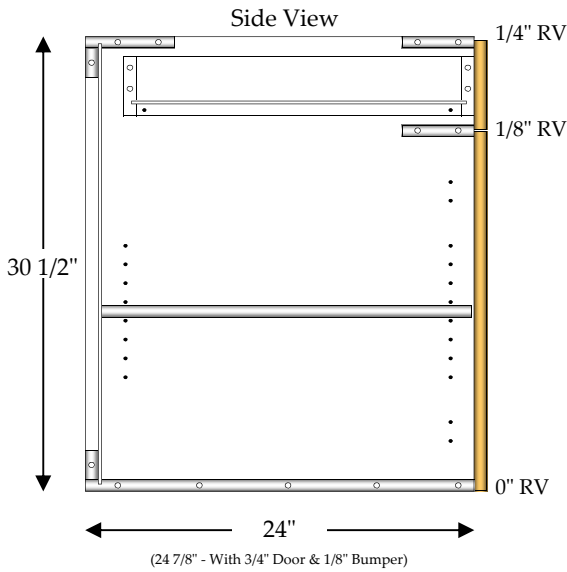

| Width | BTD |
|-------|----------|
| 9" | \$56.30 |
| 12" | \$60.62 |
| 15" | \$64.94 |
| 18" | \$69.26 |
| 21" | \$73.58 |
| 24" | \$77.90 |
| 27" | \$82.22 |
| 30" | \$86.54 |
| 33" | \$90.86 |
| 36" | \$95.18 |
| 39" | \$99.49 |
| 42" | \$103.81 |
| 45" | \$108.13 |
| 48" | \$112.45 |

| | Extrinsic Parts | | | |
|----------|-----------------|---------|---------|--|
| Box Only | AS | 4" DRW | 5" RO | |
| \$43.45 | \$3.94 | \$8.90 | \$12.08 | |
| \$45.93 | \$4.93 | \$9.75 | \$12.98 | |
| \$48.41 | \$5.92 | \$10.61 | \$13.88 | |
| \$50.89 | \$6.91 | \$11.46 | \$14.78 | |
| \$53.37 | \$7.90 | \$12.31 | \$15.68 | |
| \$55.85 | \$8.88 | \$13.16 | \$16.59 | |
| \$58.33 | \$9.87 | \$14.01 | \$17.49 | |
| \$60.81 | \$10.86 | \$14.86 | \$18.39 | |
| \$63.29 | \$11.85 | \$15.71 | \$19.29 | |
| \$65.77 | \$12.84 | \$16.56 | \$20.19 | |
| \$68.25 | \$13.83 | \$17.41 | \$21.09 | |
| \$70.73 | \$14.81 | \$18.27 | \$22.00 | |
| \$73.21 | \$15.80 | \$19.12 | \$22.90 | |
| \$75.69 | \$16.79 | \$19.97 | \$23.80 | |

Base Top Drawer / Roll Out

1 - 4" Drawer (DRW)

2 - 5" Roll Outs (RO)

Roll Outs include spacer blocks on both sides
(Spacer blocks on a single side upon request)

Specify Single Door Cabinets as **HL** or **HR**

Doors, Drawer Fronts & Hardware Not Included In Catalog Price

BTD/RO

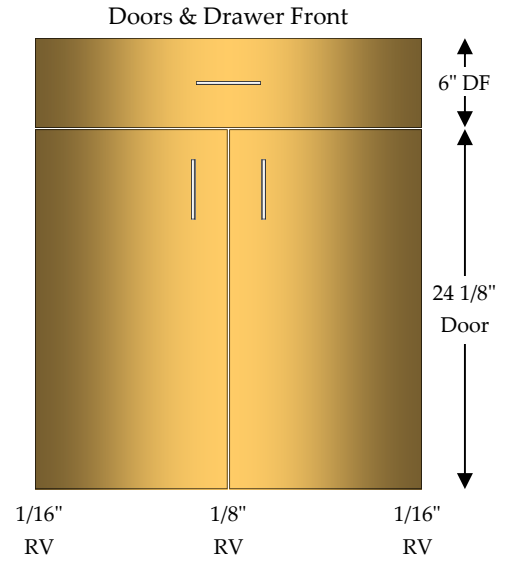
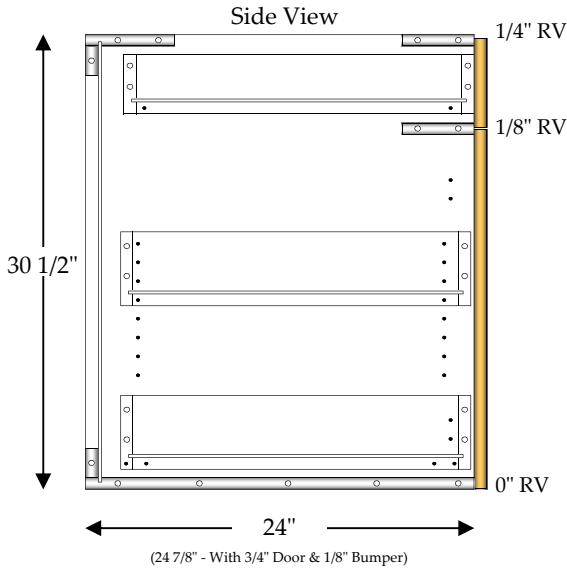

| Width | BTD/RO |
|-------|----------|
| 9" | \$76.51 |
| 12" | \$81.65 |
| 15" | \$86.78 |
| 18" | \$91.92 |
| 21" | \$97.05 |
| 24" | \$102.19 |
| 27" | \$107.32 |
| 30" | \$112.45 |
| 33" | \$117.59 |
| 36" | \$122.72 |
| 39" | \$127.86 |
| 42" | \$132.99 |
| 45" | \$138.13 |
| 48" | \$143.26 |

| Box Only | Extrinsic Parts | | |
|----------|-----------------|---------|---------|
| | AS | 4" DRW | 5" RO |
| \$43.45 | \$3.94 | \$8.90 | \$12.08 |
| \$45.93 | \$4.93 | \$9.75 | \$12.98 |
| \$48.41 | \$5.92 | \$10.61 | \$13.88 |
| \$50.89 | \$6.91 | \$11.46 | \$14.78 |
| \$53.37 | \$7.90 | \$12.31 | \$15.68 |
| \$55.85 | \$8.88 | \$13.16 | \$16.59 |
| \$58.33 | \$9.87 | \$14.01 | \$17.49 |
| \$60.81 | \$10.86 | \$14.86 | \$18.39 |
| \$63.29 | \$11.85 | \$15.71 | \$19.29 |
| \$65.77 | \$12.84 | \$16.56 | \$20.19 |
| \$68.25 | \$13.83 | \$17.41 | \$21.09 |
| \$70.73 | \$14.81 | \$18.27 | \$22.00 |
| \$73.21 | \$15.80 | \$19.12 | \$22.90 |
| \$75.69 | \$16.79 | \$19.97 | \$23.80 |

Base 2 Top Drawer

2 - 4" Top Drawers (2TD)

1 - Adjustable Shelf (AS)

Full Top, Double Partition Between Top Drawers

Specify Single Door Cabinets as HL or HR

Doors, Drawer Fronts & Hardware Not Included In Catalog Price

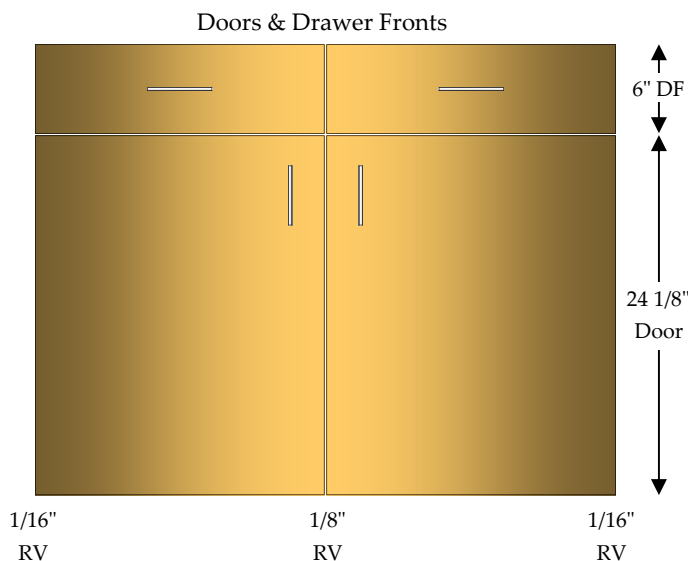
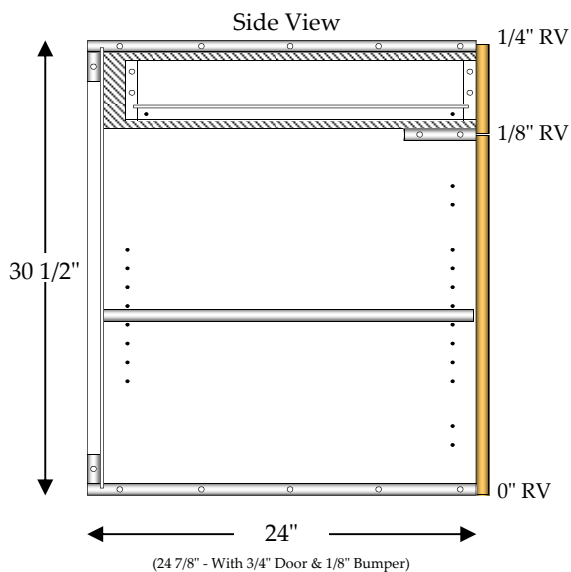

| Width | B2TD |
|-------|----------|
| 24" | \$94.10 |
| 27" | \$98.49 |
| 30" | \$102.88 |
| 33" | \$107.27 |
| 36" | \$111.65 |
| 39" | \$116.04 |
| 42" | \$120.43 |
| 45" | \$124.82 |
| 48" | \$129.21 |

| Box Only | Extrinsic Parts | | |
|----------|-----------------|--------------|---------|
| | AS | 4" 2TD (two) | 5" RO |
| \$65.71 | \$8.88 | \$19.51 | \$16.59 |
| \$68.26 | \$9.87 | \$20.36 | \$17.49 |
| \$70.81 | \$10.86 | \$21.21 | \$18.39 |
| \$73.36 | \$11.85 | \$22.06 | \$19.29 |
| \$75.90 | \$12.84 | \$22.91 | \$20.19 |
| \$78.45 | \$13.83 | \$23.76 | \$21.09 |
| \$81.00 | \$14.81 | \$24.62 | \$22.00 |
| \$83.55 | \$15.80 | \$25.47 | \$22.90 |
| \$86.10 | \$16.79 | \$26.32 | \$23.80 |

Base 2 Top Drawer / Roll Out

2 - 4" Top Drawers (2TD)

2 - 5" Roll Outs (RO)

Full Top, Double Partition Between Top Drawers
Roll Outs include spacer blocks on both sides
(Spacer blocks on a single side upon request)

Specify Single Door Cabinets as HL or HR

Doors, Drawer Fronts & Hardware Not Included In Catalog Price

B2TD/RO

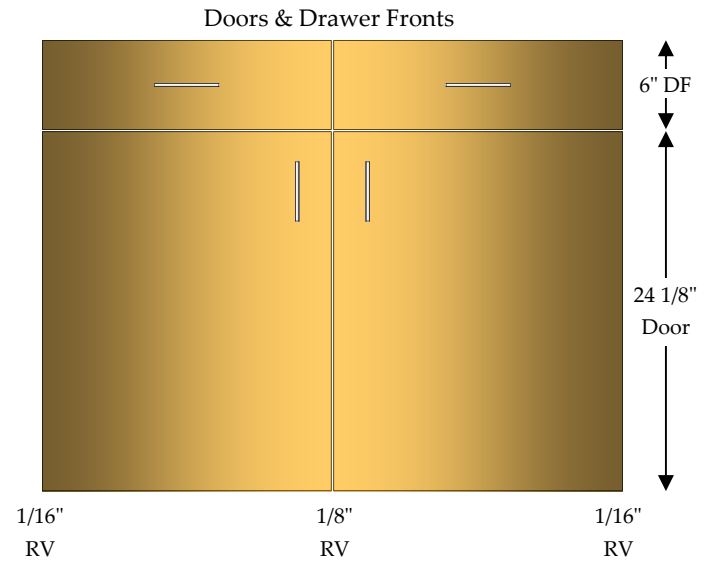
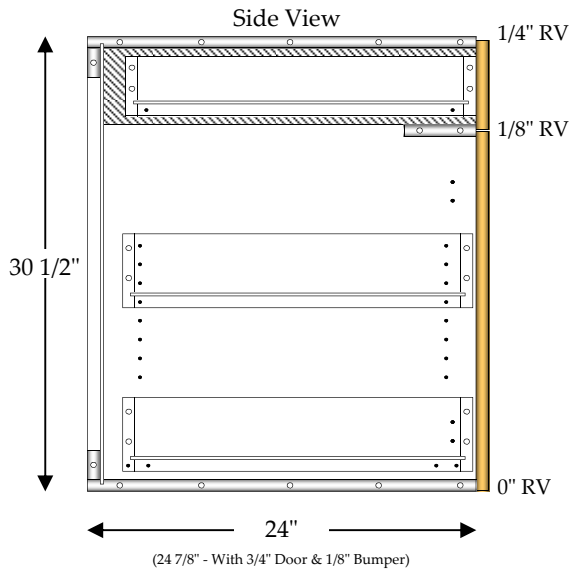

| Width | B2TD/RO |
|-------|----------|
| 24" | \$118.39 |
| 27" | \$123.59 |
| 30" | \$128.80 |
| 33" | \$134.00 |
| 36" | \$139.20 |
| 39" | \$144.41 |
| 42" | \$149.61 |
| 45" | \$154.81 |
| 48" | \$160.02 |

| Box Only | Extrinsic Parts | | |
|----------|-----------------|--------------|---------|
| | AS | 4" 2TD (two) | 5" RO |
| \$65.71 | \$8.88 | \$19.51 | \$16.59 |
| \$68.26 | \$9.87 | \$20.36 | \$17.49 |
| \$70.81 | \$10.86 | \$21.21 | \$18.39 |
| \$73.36 | \$11.85 | \$22.06 | \$19.29 |
| \$75.90 | \$12.84 | \$22.91 | \$20.19 |
| \$78.45 | \$13.83 | \$23.76 | \$21.09 |
| \$81.00 | \$14.81 | \$24.62 | \$22.00 |
| \$83.55 | \$15.80 | \$25.47 | \$22.90 |
| \$86.10 | \$16.79 | \$26.32 | \$23.80 |

Base 3 Drawer

- 1 - 4" Drawer (DRW)
2 - 10" Drawers (DRW)

B3D

Doors, Drawer Fronts & Hardware Not Included In Catalog Price

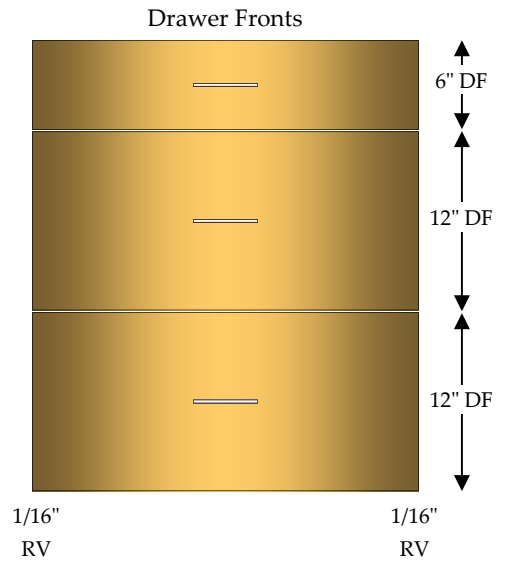
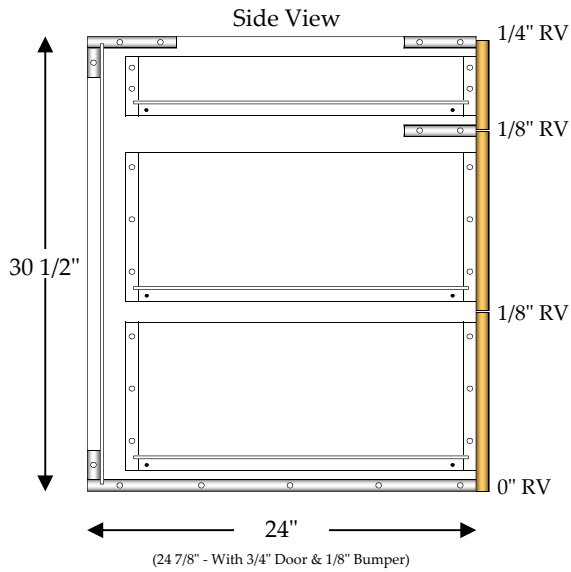

| Width | B3D |
|-------|----------|
| 9" | \$77.21 |
| 12" | \$82.82 |
| 15" | \$88.44 |
| 18" | \$94.05 |
| 21" | \$99.67 |
| 24" | \$105.28 |
| 27" | \$110.89 |
| 30" | \$116.51 |
| 33" | \$122.12 |
| 36" | \$127.74 |
| 39" | \$133.35 |
| 42" | \$138.96 |
| 45" | \$144.58 |
| 48" | \$150.19 |

| Box Only | Extrinsic Parts | | |
|----------|-----------------|---------|---------|
| | 4" DRW | 10" DRW | 9" File |
| \$43.45 | \$8.90 | \$12.43 | \$12.03 |
| \$45.93 | \$9.75 | \$13.57 | \$13.12 |
| \$48.41 | \$10.61 | \$14.71 | \$14.22 |
| \$50.89 | \$11.46 | \$15.85 | \$15.31 |
| \$53.37 | \$12.31 | \$16.99 | \$16.41 |
| \$55.85 | \$13.16 | \$18.14 | \$17.50 |
| \$58.33 | \$14.01 | \$19.28 | \$18.60 |
| \$60.81 | \$14.86 | \$20.42 | \$19.69 |
| \$63.29 | \$15.71 | \$21.56 | \$20.79 |
| \$65.77 | \$16.56 | \$22.70 | \$21.88 |
| \$68.25 | \$17.41 | \$23.84 | \$22.97 |
| \$70.73 | \$18.27 | \$24.98 | \$24.07 |
| \$73.21 | \$19.12 | \$26.13 | \$25.16 |
| \$75.69 | \$19.97 | \$27.27 | \$26.26 |

Base 3 Drawer File

1 - 4" Drawer (DRW)
2 - 9" File Drawers (F-DRW)

B3DF

Doors, Drawer Fronts & Hardware Not Included In Catalog Price

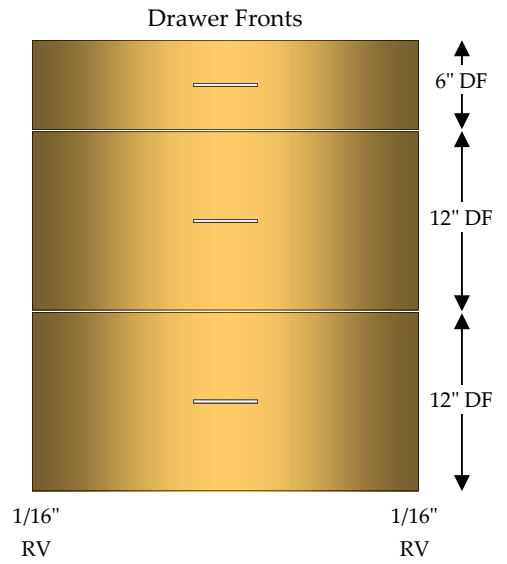
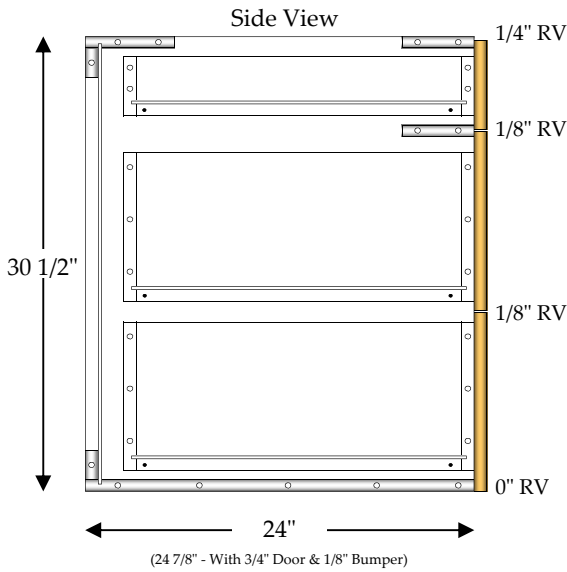

| Width | B3DF |
|-------|----------|
| 9" | \$76.41 |
| 12" | \$81.93 |
| 15" | \$87.45 |
| 18" | \$92.97 |
| 21" | \$98.49 |
| 24" | \$104.01 |
| 27" | \$109.53 |
| 30" | \$115.05 |
| 33" | \$120.57 |
| 36" | \$126.09 |
| 39" | \$131.61 |
| 42" | \$137.13 |
| 45" | \$142.65 |
| 48" | \$148.17 |

| Box Only | Extrinsic Parts | | |
|----------|-----------------|---------|----------|
| | 4" DRW | 10" DRW | 9" F-DRW |
| \$43.45 | \$8.90 | \$12.43 | \$12.03 |
| \$45.93 | \$9.75 | \$13.57 | \$13.12 |
| \$48.41 | \$10.61 | \$14.71 | \$14.22 |
| \$50.89 | \$11.46 | \$15.85 | \$15.31 |
| \$53.37 | \$12.31 | \$16.99 | \$16.41 |
| \$55.85 | \$13.16 | \$18.14 | \$17.50 |
| \$58.33 | \$14.01 | \$19.28 | \$18.60 |
| \$60.81 | \$14.86 | \$20.42 | \$19.69 |
| \$63.29 | \$15.71 | \$21.56 | \$20.79 |
| \$65.77 | \$16.56 | \$22.70 | \$21.88 |
| \$68.25 | \$17.41 | \$23.84 | \$22.97 |
| \$70.73 | \$18.27 | \$24.98 | \$24.07 |
| \$73.21 | \$19.12 | \$26.13 | \$25.16 |
| \$75.69 | \$19.97 | \$27.27 | \$26.26 |

Base 3 Drawer / 2 Top Drawer

2 - 4" Top Drawers (2TD)

2 - 10" Drawers (DRW)

Full Top, Double Partition Between Top Drawers

Doors, Drawer Fronts & Hardware Not Included In Catalog Price

B3D/2TD

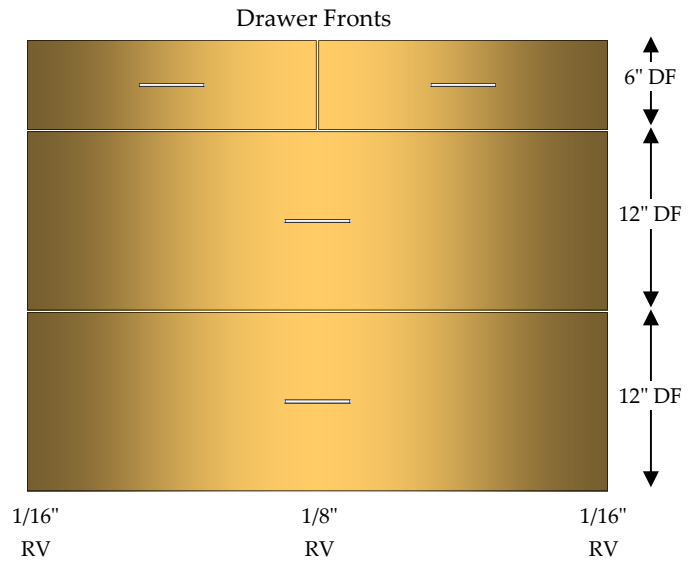
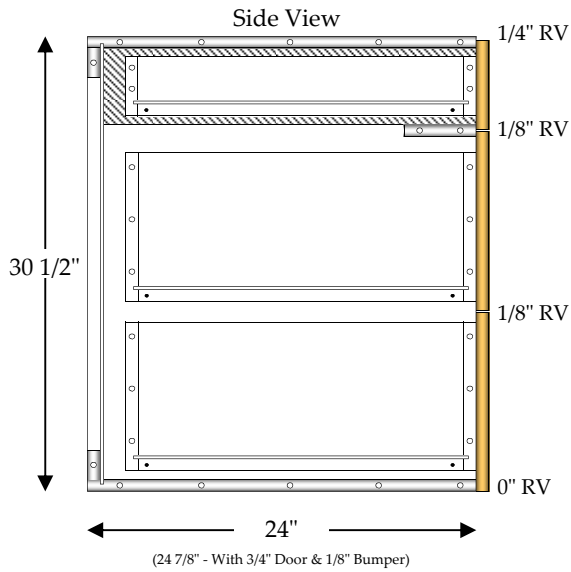

| Width | B3D/2TD |
|-------|----------|
| 24" | \$121.49 |
| 27" | \$127.17 |
| 30" | \$132.86 |
| 33" | \$138.54 |
| 36" | \$144.22 |
| 39" | \$149.90 |
| 42" | \$155.59 |
| 45" | \$161.27 |
| 48" | \$166.95 |

| Box Only | Extrinsic Parts | |
|----------|-----------------|---------|
| | 4" 2TD (two) | 10" DRW |
| \$65.71 | \$19.51 | \$18.14 |
| \$68.26 | \$20.36 | \$19.28 |
| \$70.81 | \$21.21 | \$20.42 |
| \$73.36 | \$22.06 | \$21.56 |
| \$75.90 | \$22.91 | \$22.70 |
| \$78.45 | \$23.76 | \$23.84 |
| \$81.00 | \$24.62 | \$24.98 |
| \$83.55 | \$25.47 | \$26.13 |
| \$86.10 | \$26.32 | \$27.27 |

Base 3 Drawer File / 2 Top Drawer

2 - 4" Top Drawers (2TD)

2 - 9" File Drawers (F-DRW)

Full Top, Double Partition Between Top Drawers

Doors, Drawer Fronts & Hardware Not Included In Catalog Price

B3DF/2TD

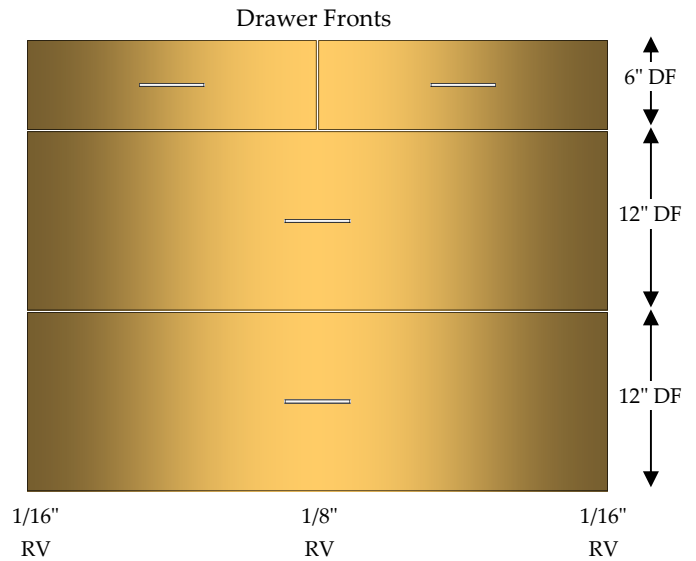
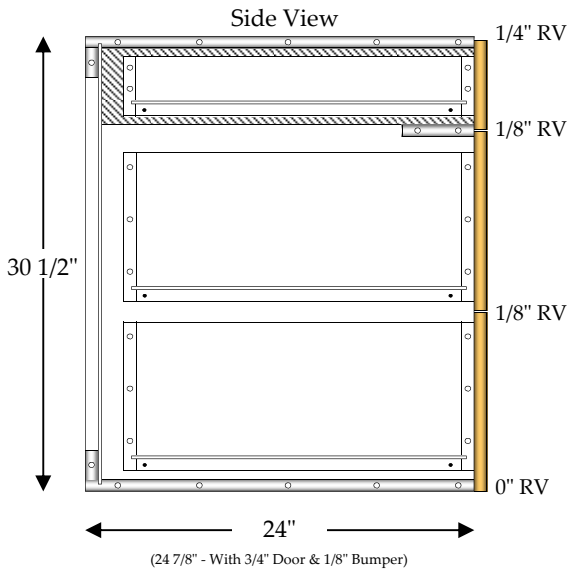

| Width | B3DF/2TD |
|-------|----------|
| 24" | \$120.22 |
| 27" | \$125.81 |
| 30" | \$131.40 |
| 33" | \$136.99 |
| 36" | \$142.58 |
| 39" | \$148.17 |
| 42" | \$153.75 |
| 45" | \$159.34 |
| 48" | \$164.93 |

| Box Only | Extrinsic Parts | |
|----------|-----------------|----------|
| | 4" 2TD (two) | 9" F-DRW |
| \$65.71 | \$19.51 | \$17.50 |
| \$68.26 | \$20.36 | \$18.60 |
| \$70.81 | \$21.21 | \$19.69 |
| \$73.36 | \$22.06 | \$20.79 |
| \$75.90 | \$22.91 | \$21.88 |
| \$78.45 | \$23.76 | \$22.97 |
| \$81.00 | \$24.62 | \$24.07 |
| \$83.55 | \$25.47 | \$25.16 |
| \$86.10 | \$26.32 | \$26.26 |

Base 4 Drawer

2 - 4" Drawers (DRW)

2 - 7" Drawers (DRW)

Doors, Drawer Fronts & Hardware Not Included In Catalog Price

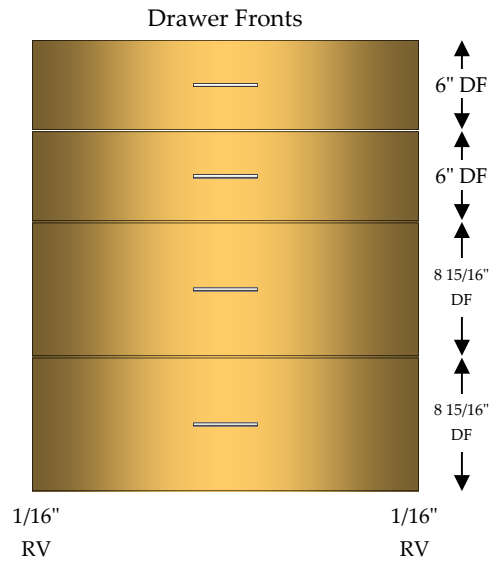
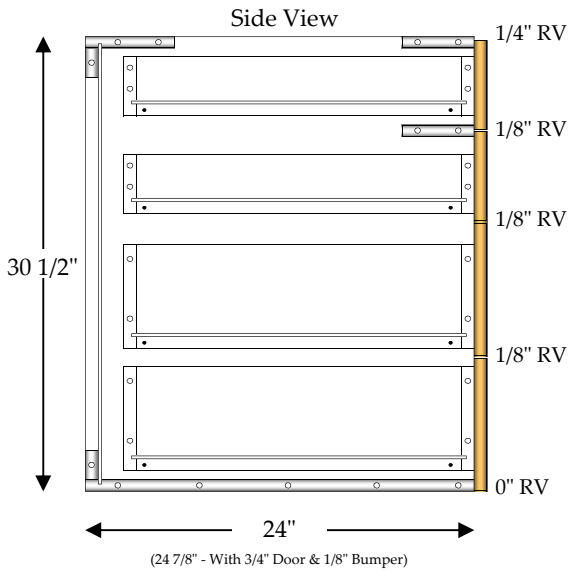

Extrinsic Parts

| Width | B4D |
|-------|----------|
| 9" | \$82.81 |
| 12" | \$89.00 |
| 15" | \$95.19 |
| 18" | \$101.38 |
| 21" | \$107.57 |
| 24" | \$113.76 |
| 27" | \$119.95 |
| 30" | \$126.14 |
| 33" | \$132.33 |
| 36" | \$138.52 |
| 39" | \$144.71 |
| 42" | \$150.90 |
| 45" | \$157.09 |
| 48" | \$163.28 |

| Box Only | 4" DRW | 7" DRW |
|----------|---------|---------|
| \$43.45 | \$8.90 | \$10.77 |
| \$45.93 | \$9.75 | \$11.78 |
| \$48.41 | \$10.61 | \$12.78 |
| \$50.89 | \$11.46 | \$13.79 |
| \$53.37 | \$12.31 | \$14.79 |
| \$55.85 | \$13.16 | \$15.79 |
| \$58.33 | \$14.01 | \$16.80 |
| \$60.81 | \$14.86 | \$17.80 |
| \$63.29 | \$15.71 | \$18.80 |
| \$65.77 | \$16.56 | \$19.81 |
| \$68.25 | \$17.41 | \$20.81 |
| \$70.73 | \$18.27 | \$21.82 |
| \$73.21 | \$19.12 | \$22.82 |
| \$75.69 | \$19.97 | \$23.82 |

Base 4 Drawer / 2 Top Drawer

2 - 4" Top Drawers (2TD)

1 - 4" Drawer (DRW)

2 - 7" Drawers (DRW)

B4D/2TD

Full Top, Double Partition Between Top Drawers

Doors, Drawer Fronts & Hardware Not Included In Catalog Price

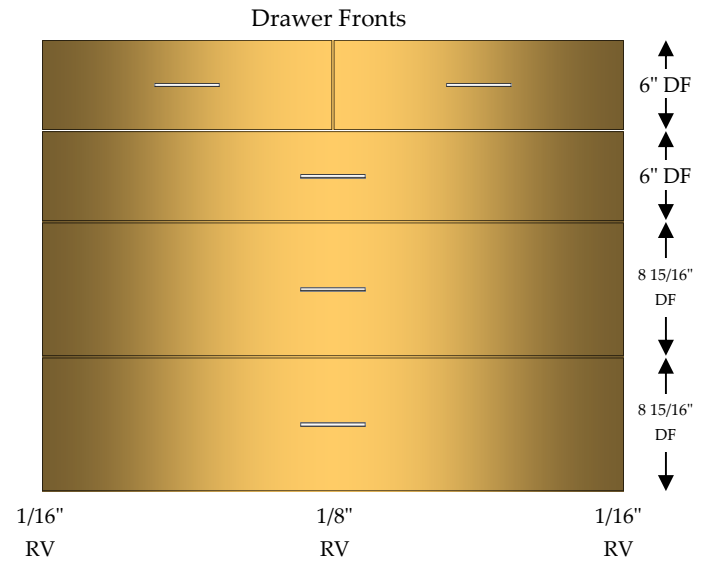
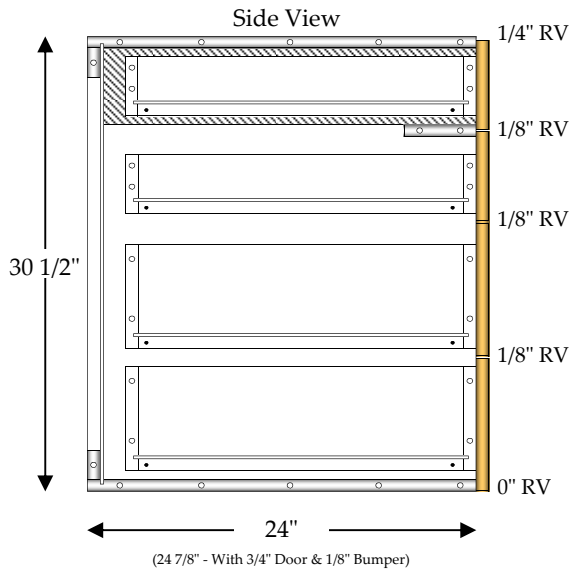

| Width | B4D/2TD |
|-------|----------|
| 24" | \$129.97 |
| 27" | \$136.22 |
| 30" | \$142.48 |
| 33" | \$148.74 |
| 36" | \$155.00 |
| 39" | \$161.26 |
| 42" | \$167.51 |
| 45" | \$173.77 |
| 48" | \$180.03 |

| Box Only | Extrinsic Parts | | |
|----------|-----------------|---------|--------------|
| | 4" DRW | 7" DRW | 4" 2TD (two) |
| \$65.71 | \$13.16 | \$15.79 | \$19.51 |
| \$68.26 | \$14.01 | \$16.80 | \$20.36 |
| \$70.81 | \$14.86 | \$17.80 | \$21.21 |
| \$73.36 | \$15.71 | \$18.80 | \$22.06 |
| \$75.90 | \$16.56 | \$19.81 | \$22.91 |
| \$78.45 | \$17.41 | \$20.81 | \$23.76 |
| \$81.00 | \$18.27 | \$21.82 | \$24.62 |
| \$83.55 | \$19.12 | \$22.82 | \$25.47 |
| \$86.10 | \$19.97 | \$23.82 | \$26.32 |

Base 5 Drawer
5 - 4" Drawers (DRW)

B5D

Doors, Drawer Fronts & Hardware Not Included In Catalog Price

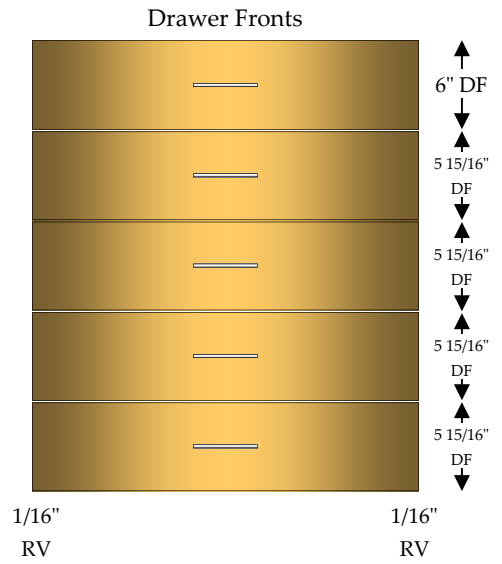
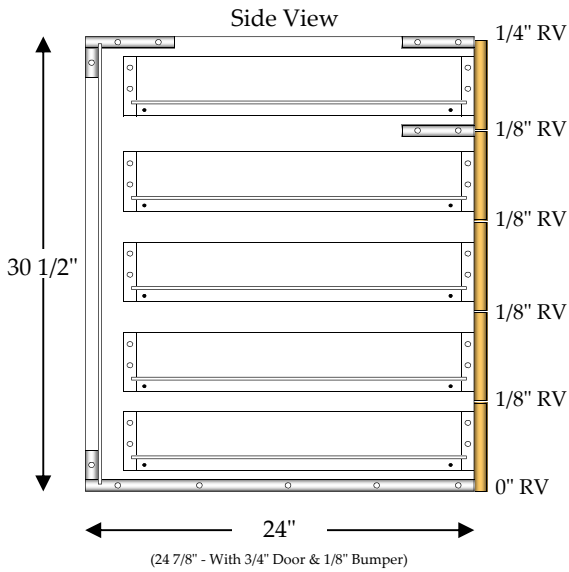

| Width | B5D |
|-------|------------|
| 9" | \$87.97 |
| 12" | \$94.70 |
| 15" | \$101.44 |
| 18" | \$108.18 |
| 21" | \$114.91 |
| 24" | \$121.65 |
| 27" | \$128.38 |
| 30" | \$135.12 |
| 33" | \$141.86 |
| 36" | \$148.59 |
| 39" | \$155.33 |
| 42" | \$162.06 |
| 45" | \$168.80 |
| 48" | \$175.54 |

| Box Only | 4" DRW |
|-----------------|---------------|
| \$43.45 | \$8.90 |
| \$45.93 | \$9.75 |
| \$48.41 | \$10.61 |
| \$50.89 | \$11.46 |
| \$53.37 | \$12.31 |
| \$55.85 | \$13.16 |
| \$58.33 | \$14.01 |
| \$60.81 | \$14.86 |
| \$63.29 | \$15.71 |
| \$65.77 | \$16.56 |
| \$68.25 | \$17.41 |
| \$70.73 | \$18.27 |
| \$73.21 | \$19.12 |
| \$75.69 | \$19.97 |

Base 5 Drawer / 2 Top Drawer

2 - 4" Top Drawers (2TD)

4 - 4" Drawers (DRW)

Full Top, Double Partition Between Top Drawers

Doors, Drawer Fronts & Hardware Not Included In Catalog Price

B5D/2TD

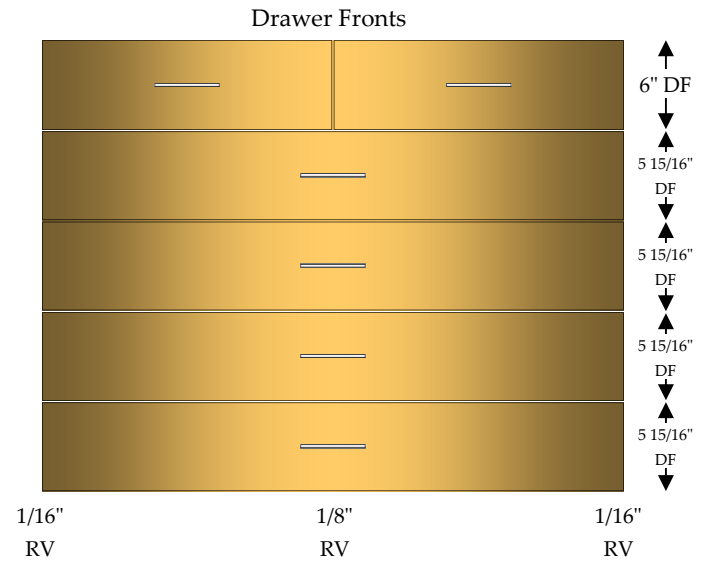
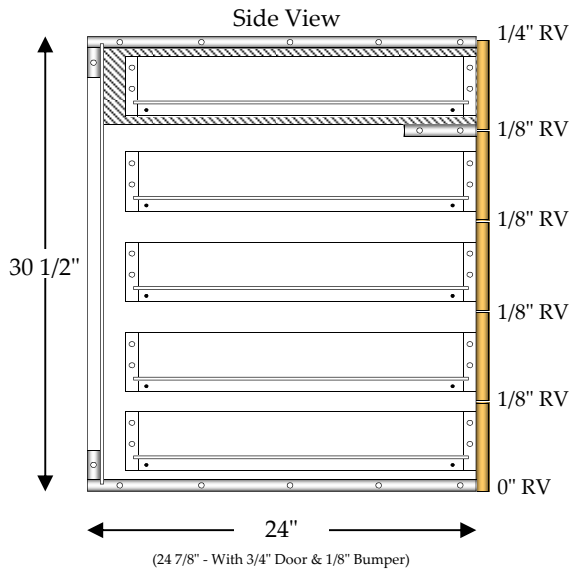

| Width | B5D/2TD |
|-------|----------|
| 24" | \$137.85 |
| 27" | \$144.66 |
| 30" | \$151.46 |
| 33" | \$158.27 |
| 36" | \$165.07 |
| 39" | \$171.88 |
| 42" | \$178.68 |
| 45" | \$185.48 |
| 48" | \$192.29 |

| Extrinsic Parts | | |
|-----------------|---------|--------------|
| Box Only | 4" DRW | 4" 2TD (two) |
| \$65.71 | \$13.16 | \$19.51 |
| \$68.26 | \$14.01 | \$20.36 |
| \$70.81 | \$14.86 | \$21.21 |
| \$73.36 | \$15.71 | \$22.06 |
| \$75.90 | \$16.56 | \$22.91 |
| \$78.45 | \$17.41 | \$23.76 |
| \$81.00 | \$18.27 | \$24.62 |
| \$83.55 | \$19.12 | \$25.47 |
| \$86.10 | \$19.97 | \$26.32 |

Base Microwave Drawer

1-9" Drawer (DRW)

1-Fixed Shelf (FS)

Specify Microwave Opening for FS Placement
Specify Drawer Front Overlay on FS for DF Size

Doors, Drawer Fronts & Hardware Not Included In Catalog Price

BMD

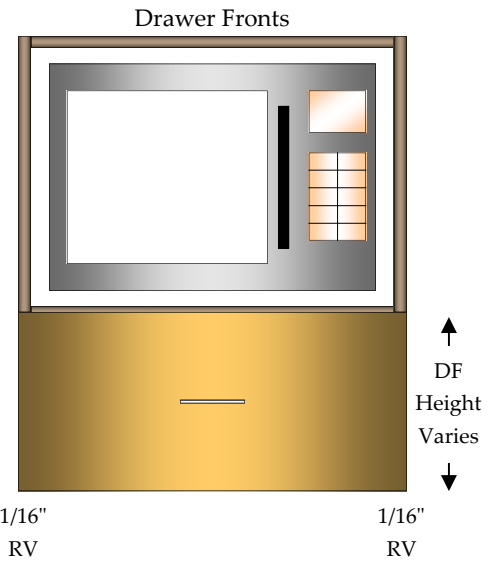
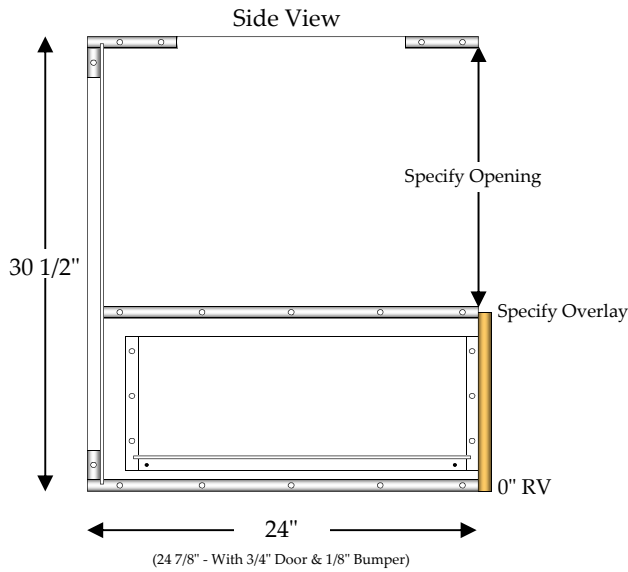

| Width | BMD |
|-------|----------|
| 24" | \$85.11 |
| 27" | \$89.05 |
| 30" | \$92.98 |
| 33" | \$96.92 |
| 36" | \$100.86 |

| Box Only | Extrinsic Parts | | |
|----------|-----------------|---------|---------|
| | 7" DRW | 8" DRW | 9" DRW |
| \$67.61 | \$15.79 | \$16.54 | \$17.50 |
| \$70.45 | \$16.80 | \$17.59 | \$18.60 |
| \$73.29 | \$17.80 | \$18.64 | \$19.69 |
| \$76.13 | \$18.80 | \$19.70 | \$20.79 |
| \$78.98 | \$19.81 | \$20.75 | \$21.88 |

Base Sink Unit

BSU

Specify Single Door Cabinets as **HL** or **HR**

Doors, Drawer Fronts & Hardware Not Included In Catalog Price

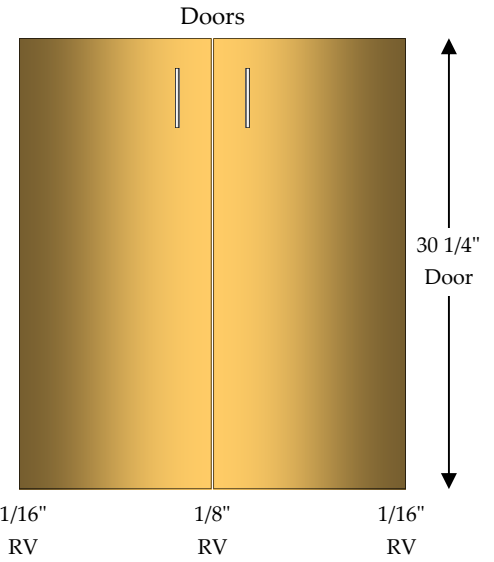
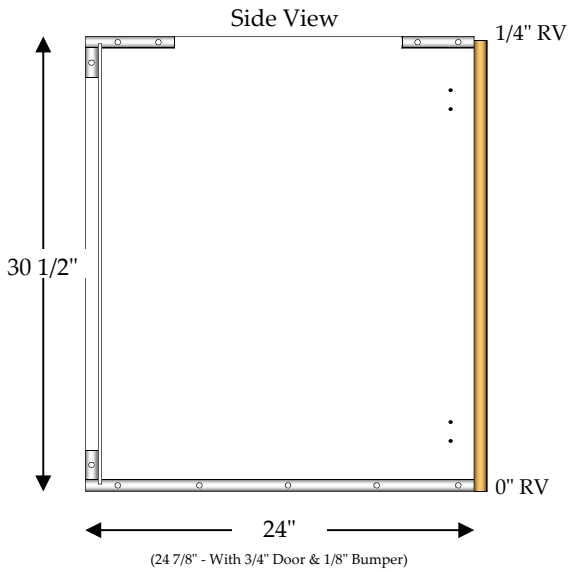

| Width | BSU |
|-------|---------|
| 9" | \$40.38 |
| 12" | \$42.63 |
| 15" | \$44.88 |
| 18" | \$47.13 |
| 21" | \$49.38 |
| 24" | \$51.63 |
| 27" | \$53.88 |
| 30" | \$56.13 |
| 33" | \$58.38 |
| 36" | \$60.63 |
| 39" | \$62.88 |
| 42" | \$65.13 |
| 45" | \$67.38 |
| 48" | \$69.63 |

Extrinsic Parts

| AS | 5" RO |
|---------|---------|
| \$3.94 | \$12.08 |
| \$4.93 | \$12.98 |
| \$5.92 | \$13.88 |
| \$6.91 | \$14.78 |
| \$7.90 | \$15.68 |
| \$8.88 | \$16.59 |
| \$9.87 | \$17.49 |
| \$10.86 | \$18.39 |
| \$11.85 | \$19.29 |
| \$12.84 | \$20.19 |
| \$13.83 | \$21.09 |
| \$14.81 | \$22.00 |
| \$15.80 | \$22.90 |
| \$16.79 | \$23.80 |



585 North 700 West Suit A-B, North Salt Lake, UT 84054

Email: acc@alphacabinets.com
<http://www.alphacabinets.com>

Phone: 801-295-9417
Fax: 801-292-2762

[Return to Base Menu](#)

B17

Base Sink False Front

BSFF

2 - Particle Board Blocks to Mount False Front

Specify Single Door Cabinets as **HL** or **HR**

Doors, Drawer Fronts & Hardware Not Included In Catalog Price

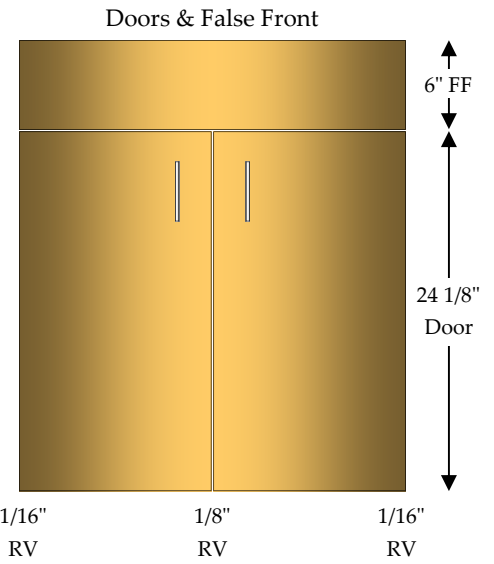
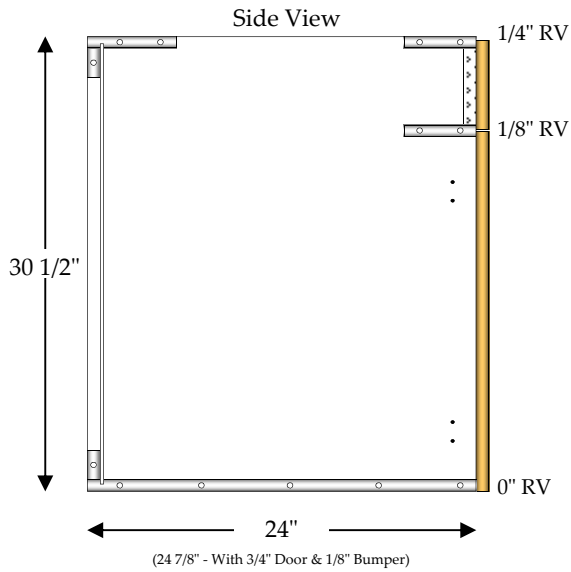

| Width | BSFF |
|-------|---------|
| 9" | \$44.64 |
| 12" | \$47.12 |
| 15" | \$49.60 |
| 18" | \$52.08 |
| 21" | \$54.56 |
| 24" | \$57.04 |
| 27" | \$59.52 |
| 30" | \$62.00 |
| 33" | \$64.48 |
| 36" | \$66.96 |
| 39" | \$69.44 |
| 42" | \$71.92 |
| 45" | \$74.40 |
| 48" | \$76.88 |

Extrinsic Parts

| AS | 5" RO |
|---------|---------|
| \$3.94 | \$12.08 |
| \$4.93 | \$12.98 |
| \$5.92 | \$13.88 |
| \$6.91 | \$14.78 |
| \$7.90 | \$15.68 |
| \$8.88 | \$16.59 |
| \$9.87 | \$17.49 |
| \$10.86 | \$18.39 |
| \$11.85 | \$19.29 |
| \$12.84 | \$20.19 |
| \$13.83 | \$21.09 |
| \$14.81 | \$22.00 |
| \$15.80 | \$22.90 |
| \$16.79 | \$23.80 |

Base Sink 2 False Front

BS2FF

Double Partition Between False Fronts
4 - Particle Board Blocks to Mount False Front

Specify Single Door Cabinets as **HL** or **HR**

Doors, Drawer Fronts & Hardware Not Included In Catalog Price

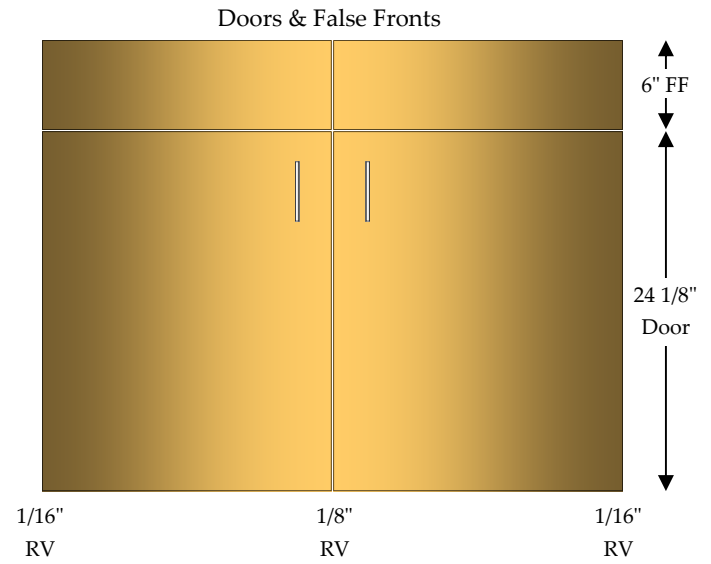
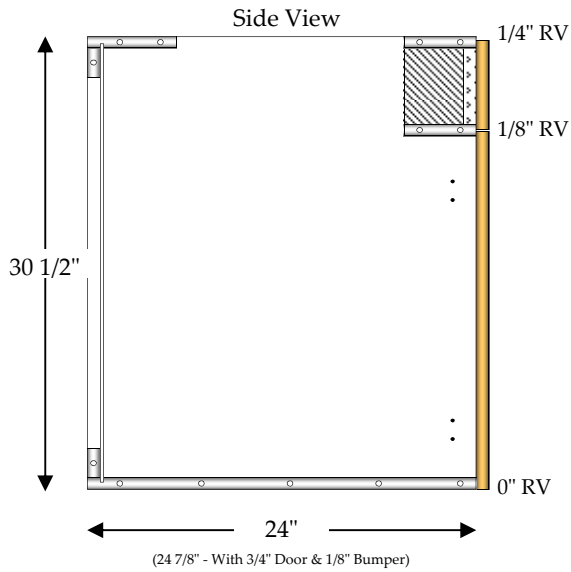

| Width | BS2FF |
|-------|---------|
| 24" | \$57.47 |
| 27" | \$59.95 |
| 30" | \$62.43 |
| 33" | \$64.91 |
| 36" | \$67.39 |
| 39" | \$69.87 |
| 42" | \$72.35 |
| 45" | \$74.83 |
| 48" | \$77.31 |

| Extrinsic Parts | |
|-----------------|---------|
| AS | 5" RO |
| \$8.88 | \$16.59 |
| \$9.87 | \$17.49 |
| \$10.86 | \$18.39 |
| \$11.85 | \$19.29 |
| \$12.84 | \$20.19 |
| \$13.83 | \$21.09 |
| \$14.81 | \$22.00 |
| \$15.80 | \$22.90 |
| \$16.79 | \$23.80 |

Base Sink Unit Apron

1 - 7" Apron
Top Hinge (Bore Doors 9" on Center)

Specify Single Door Cabinets as **HL** or **HR**

Doors, Drawer Fronts & Hardware Not Included In Catalog Price

BSUA

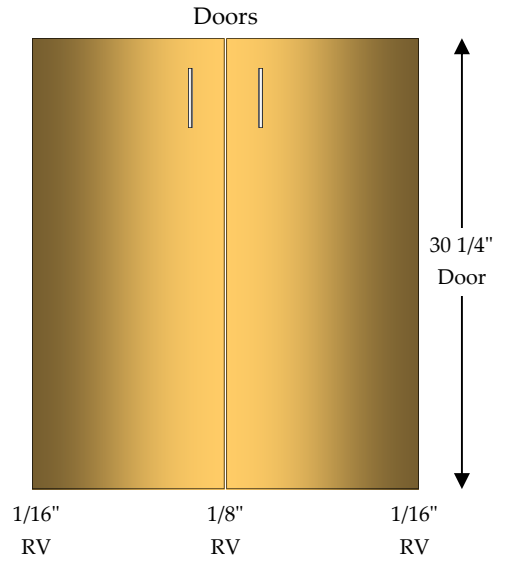
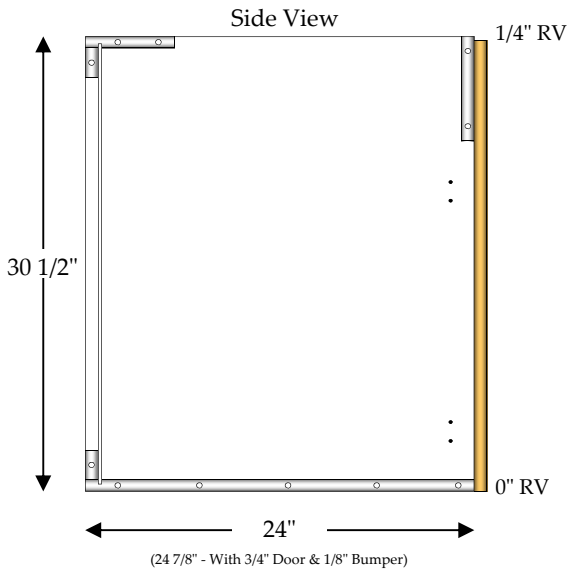

| Width | BSUA |
|-------|---------|
| 9" | \$41.27 |
| 12" | \$43.61 |
| 15" | \$45.95 |
| 18" | \$48.28 |
| 21" | \$50.62 |
| 24" | \$52.95 |
| 27" | \$55.29 |
| 30" | \$57.62 |
| 33" | \$59.96 |
| 36" | \$62.30 |
| 39" | \$64.63 |
| 42" | \$66.97 |
| 45" | \$69.30 |
| 48" | \$71.64 |

Extrinsic Parts

| AS | 5" RO |
|---------|---------|
| \$3.94 | \$12.08 |
| \$4.93 | \$12.98 |
| \$5.92 | \$13.88 |
| \$6.91 | \$14.78 |
| \$7.90 | \$15.68 |
| \$8.88 | \$16.59 |
| \$9.87 | \$17.49 |
| \$10.86 | \$18.39 |
| \$11.85 | \$19.29 |
| \$12.84 | \$20.19 |
| \$13.83 | \$21.09 |
| \$14.81 | \$22.00 |
| \$15.80 | \$22.90 |
| \$16.79 | \$23.80 |

Base Sink False Front Apron

BSFFA

1 - 7" Apron

Specify Single Door Cabinets as **HL** or **HR**

Doors, Drawer Fronts & Hardware Not Included In Catalog Price

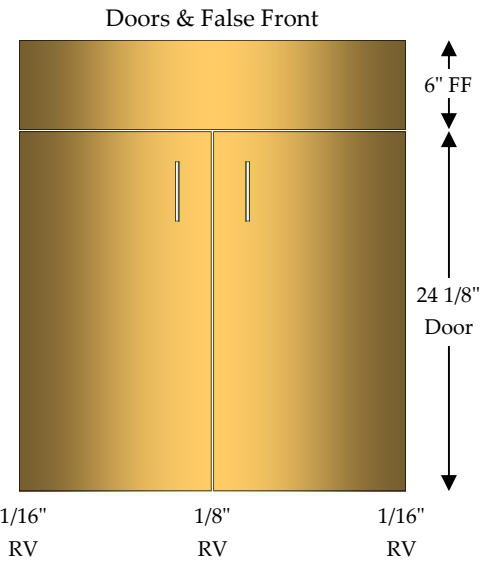
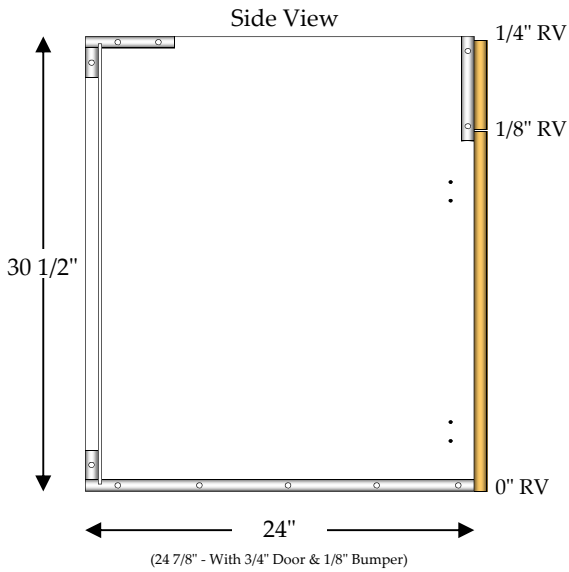

| Width | BSFFA |
|-------|---------|
| 9" | \$41.27 |
| 12" | \$43.61 |
| 15" | \$45.95 |
| 18" | \$48.28 |
| 21" | \$50.62 |
| 24" | \$52.95 |
| 27" | \$55.29 |
| 30" | \$57.62 |
| 33" | \$59.96 |
| 36" | \$62.30 |
| 39" | \$64.63 |
| 42" | \$66.97 |
| 45" | \$69.30 |
| 48" | \$71.64 |

Extrinsic Parts

| AS | 5" RO |
|---------|---------|
| \$3.94 | \$12.08 |
| \$4.93 | \$12.98 |
| \$5.92 | \$13.88 |
| \$6.91 | \$14.78 |
| \$7.90 | \$15.68 |
| \$8.88 | \$16.59 |
| \$9.87 | \$17.49 |
| \$10.86 | \$18.39 |
| \$11.85 | \$19.29 |
| \$12.84 | \$20.19 |
| \$13.83 | \$21.09 |
| \$14.81 | \$22.00 |
| \$15.80 | \$22.90 |
| \$16.79 | \$23.80 |

Base Sink 2 False Front Apron

BS2FFA

1 - 7" Apron

Specify Single Door Cabinets as **HL** or **HR**

Doors, Drawer Fronts & Hardware Not Included In Catalog Price

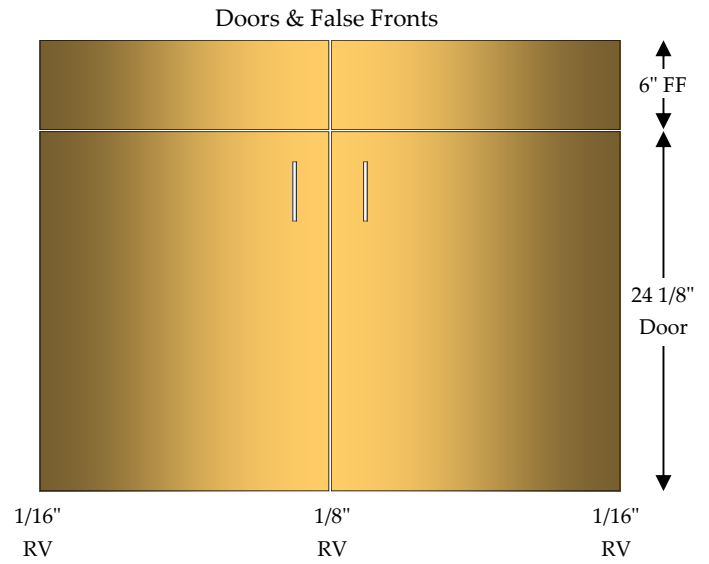
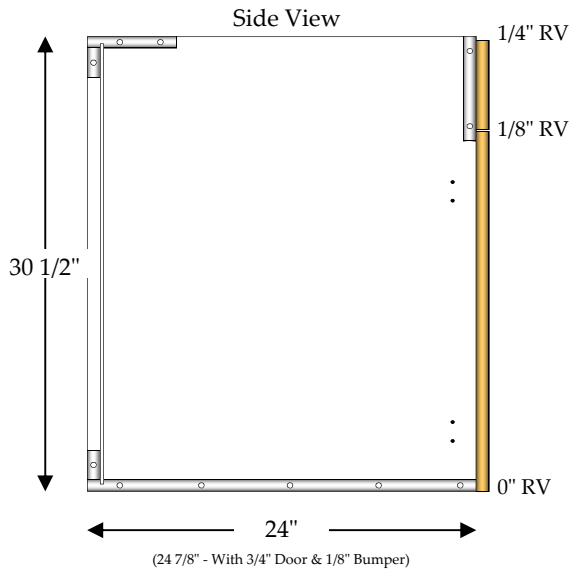

| Width | BS2FFA |
|-------|---------|
| 24" | \$52.95 |
| 27" | \$55.29 |
| 30" | \$57.62 |
| 33" | \$59.96 |
| 36" | \$62.30 |
| 39" | \$64.63 |
| 42" | \$66.97 |
| 45" | \$69.30 |
| 48" | \$71.64 |

| Extrinsic Parts | |
|-----------------|---------|
| AS | 5" RO |
| \$8.88 | \$16.59 |
| \$9.87 | \$17.49 |
| \$10.86 | \$18.39 |
| \$11.85 | \$19.29 |
| \$12.84 | \$20.19 |
| \$13.83 | \$21.09 |
| \$14.81 | \$22.00 |
| \$15.80 | \$22.90 |
| \$16.79 | \$23.80 |

Base Sink False Front / 45° Corner

BSFF/45C

2 - Particle Board Blocks to Mount False Front
Mid Spreader requires customer placement

Specify Single Door Cabinets as **HL** or **HR**

Doors, Drawer Fronts & Hardware Not Included In Catalog Price

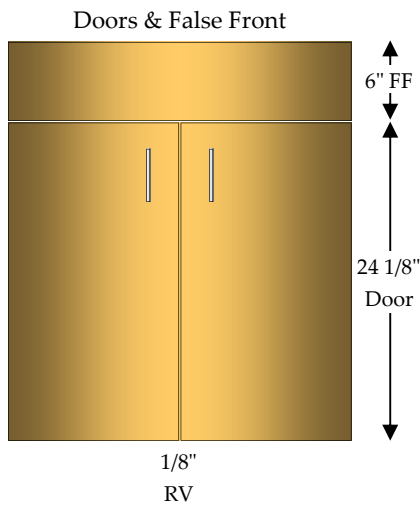
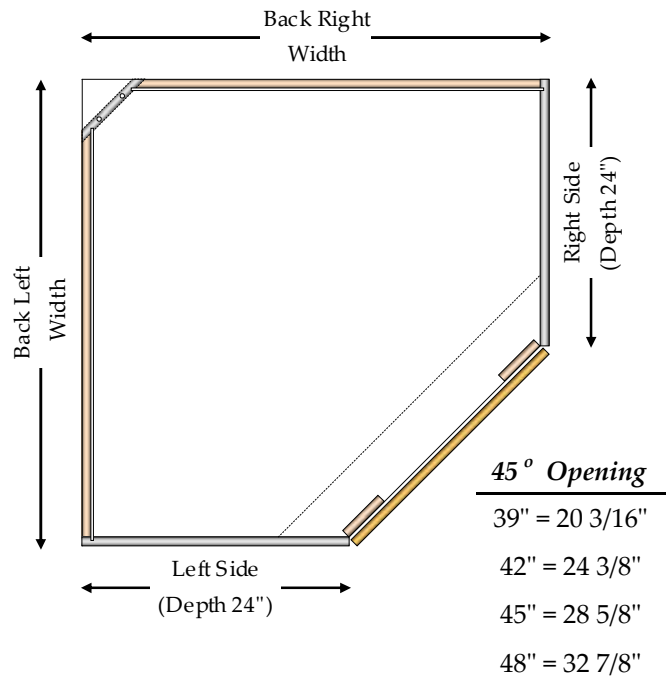
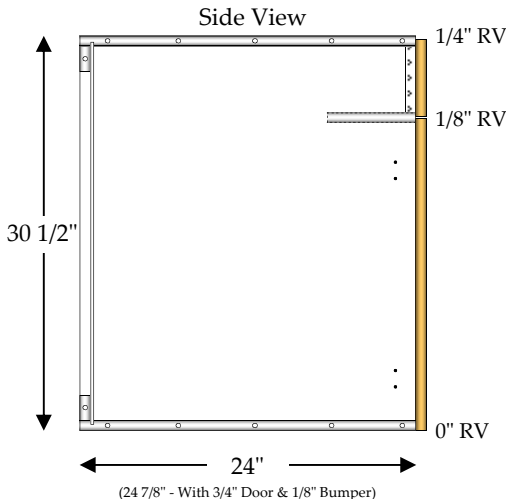

| Width | BSFF/45C |
|-------|----------|
| 39" | \$111.34 |
| 42" | \$119.70 |
| 45" | \$128.24 |
| 48" | \$136.95 |

| AS |
|---------|
| \$22.93 |
| \$25.09 |
| \$27.34 |
| \$29.68 |

Base Unit / 45° Corner

1 - Adjustable Shelf (AS)

BU/45C

Specify Single Door Cabinets as HL or HR

Doors, Drawer Fronts & Hardware Not Included In Catalog Price

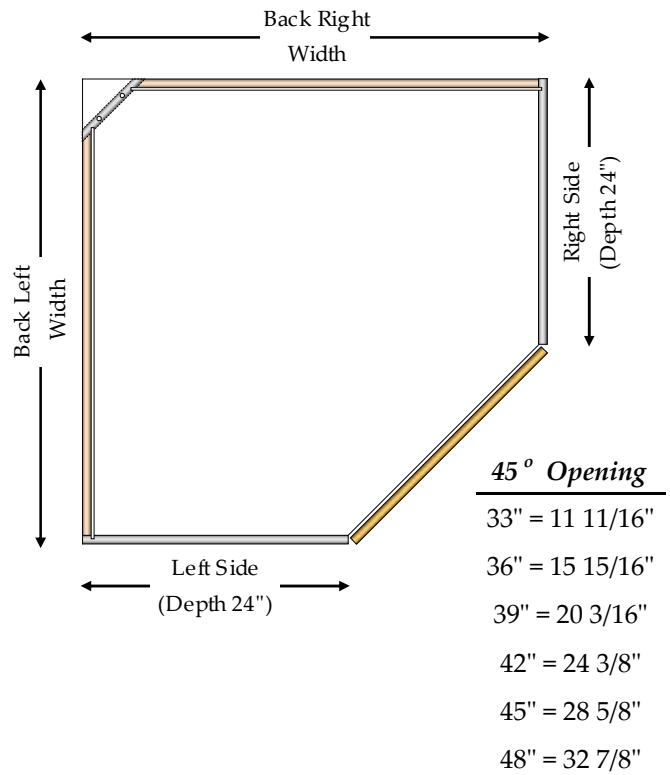
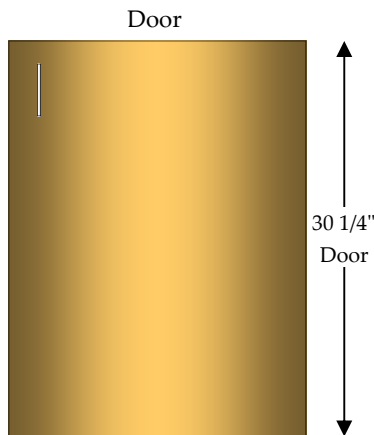
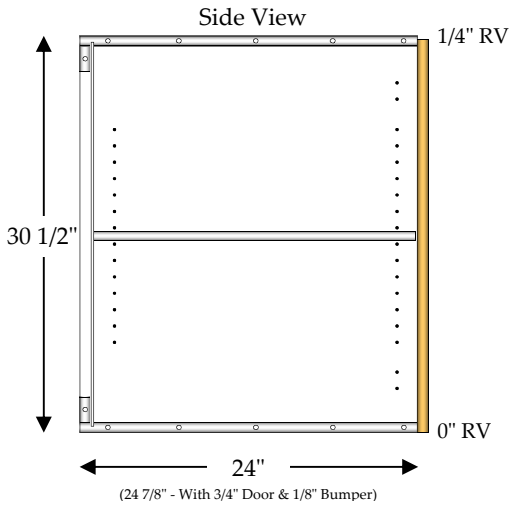

| Width | BU/45C |
|-------|----------|
| 33" | \$106.12 |
| 36" | \$116.07 |
| 39" | \$126.28 |
| 42" | \$136.75 |
| 45" | \$147.47 |
| 48" | \$158.45 |

| Box Only | AS |
|----------|---------|
| \$87.26 | \$18.86 |
| \$95.22 | \$20.85 |
| \$103.35 | \$22.93 |
| \$111.65 | \$25.09 |
| \$120.13 | \$27.34 |
| \$128.77 | \$29.68 |

Base Unit / 90° Corner

1 - Adjustable Shelf (AS)

BU/90C

Specify Single Door Cabinets as HL or HR

Doors, Drawer Fronts & Hardware Not Included In Catalog Price

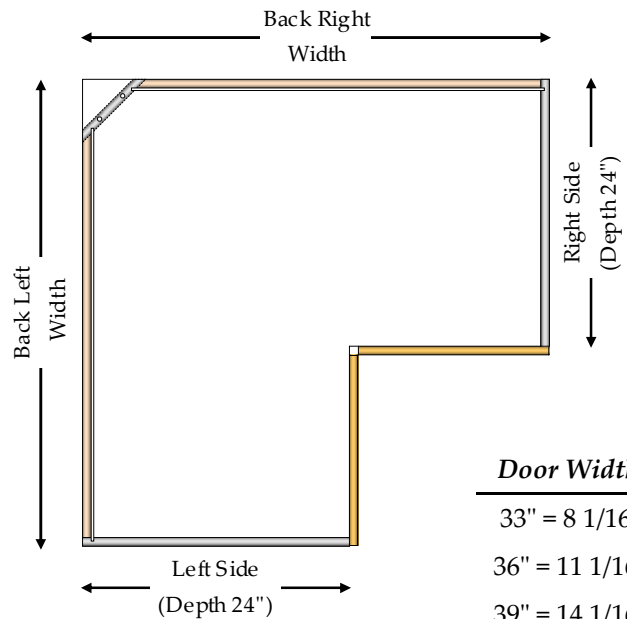
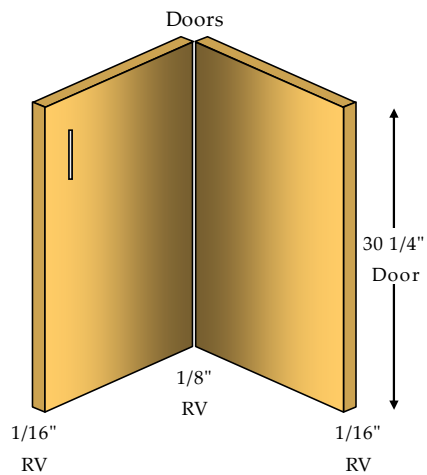
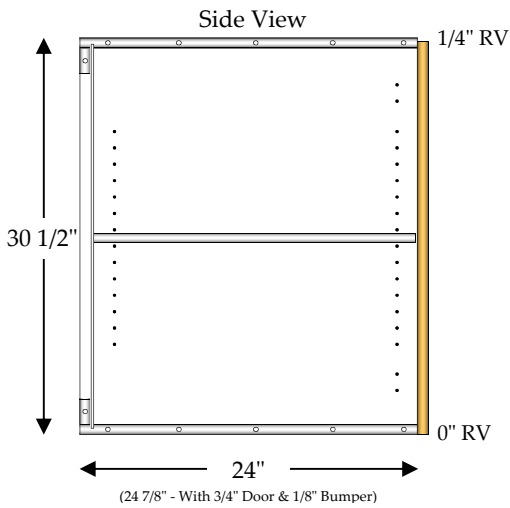

Door Width

| | |
|-----|------------|
| 33" | = 8 1/16" |
| 36" | = 11 1/16" |
| 39" | = 14 1/16" |
| 42" | = 17 1/16" |
| 45" | = 20 1/16" |
| 48" | = 23 1/16" |

| Width | BU/90C |
|-------|----------|
| 33" | \$123.91 |
| 36" | \$134.78 |
| 39" | \$145.91 |
| 42" | \$157.30 |
| 45" | \$168.94 |
| 48" | \$180.84 |

| Box Only | AS |
|----------|---------|
| \$101.21 | \$22.70 |
| \$109.82 | \$24.96 |
| \$118.60 | \$27.31 |
| \$127.55 | \$29.74 |
| \$136.68 | \$32.26 |
| \$145.97 | \$34.87 |



585 North 700 West Suit A-B, North Salt Lake, UT 84054

Email: acc@alphacabinets.com
<http://www.alphacabinets.com>

Phone: 801-295-9417
 Fax: 801-292-2762

[Return to Base Menu](#)

B25

Base Unit / Blind Corner Left

1 - Adjustable Shelf (AS)

1 - 27" Blind Panel

Specify Single Door Cabinets as **HL** or **HR**

Doors, Drawer Fronts & Hardware Not Included In Catalog Price

BU/BCL

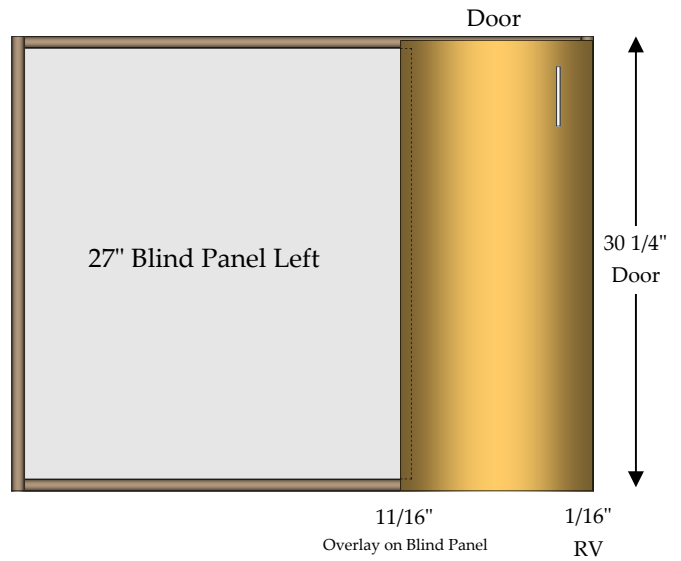
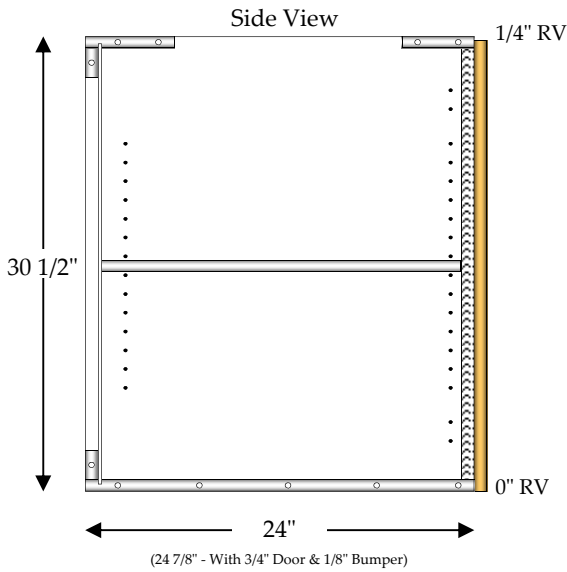

| Width | BU/BCL |
|-------|----------|
| 36" | \$100.34 |
| 39" | \$103.57 |
| 42" | \$106.81 |
| 45" | \$110.05 |
| 48" | \$113.29 |

| Box Only | AS |
|----------|---------|
| \$87.50 | \$12.84 |
| \$89.75 | \$13.83 |
| \$92.00 | \$14.81 |
| \$94.25 | \$15.80 |
| \$96.50 | \$16.79 |

Base Unit / Blind Corner Right

1 - Adjustable Shelf (AS)

1 - 27" Blind Panel

Specify Single Door Cabinets as HL or HR

Doors, Drawer Fronts & Hardware Not Included In Catalog Price

BU/BCR

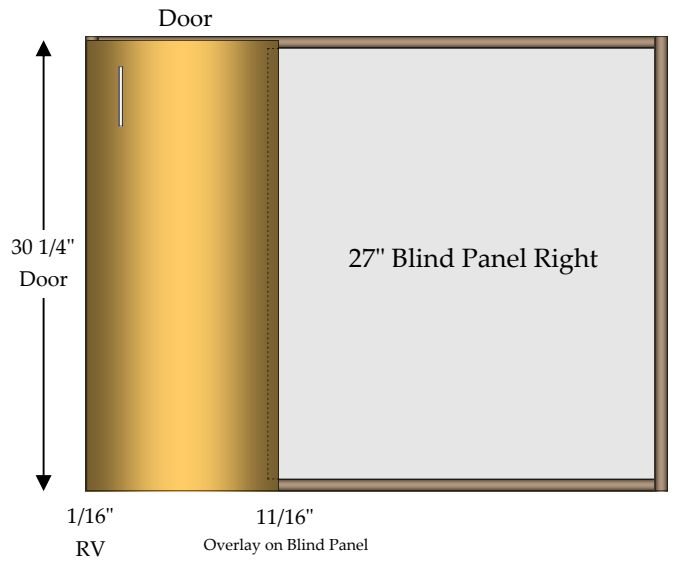
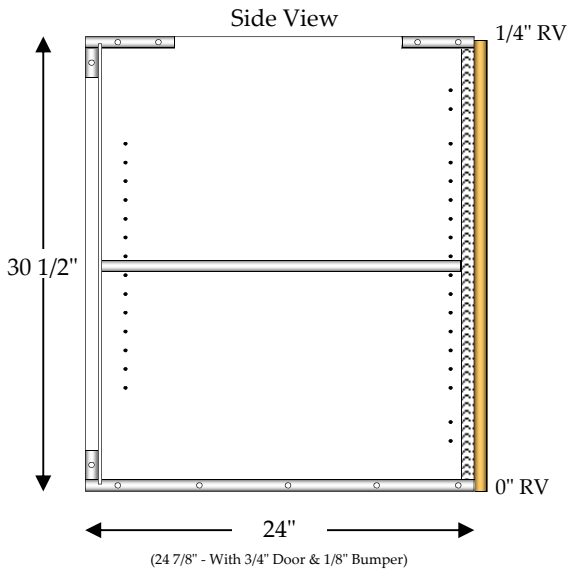

| Width | BU/BCR |
|-------|----------|
| 36" | \$100.34 |
| 39" | \$103.57 |
| 42" | \$106.81 |
| 45" | \$110.05 |
| 48" | \$113.29 |

| Box Only | AS |
|----------|---------|
| \$87.50 | \$12.84 |
| \$89.75 | \$13.83 |
| \$92.00 | \$14.81 |
| \$94.25 | \$15.80 |
| \$96.50 | \$16.79 |

Base Top Drawer / Blind Corner Left

- 1 - 4" Drawer (DRW)
- 1 - Adjustable Shelf (AS)

1 - 27" Blind Panel

Specify Single Door Cabinets as **HL** or **HR**

Doors, Drawer Fronts & Hardware Not Included In Catalog Price

BTD/BCL

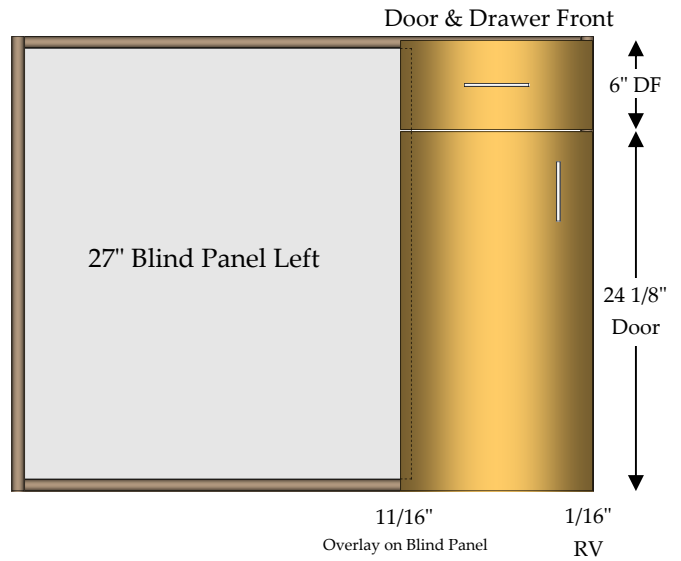
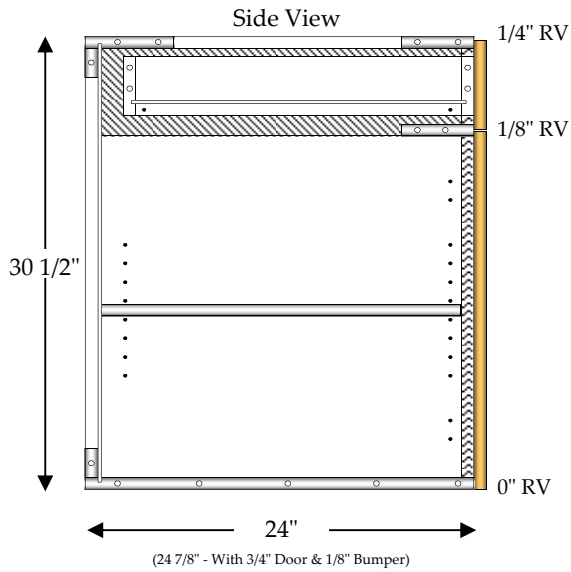

| Width | BTD/BCL |
|-------|----------|
| 36" | \$117.59 |
| 39" | \$121.74 |
| 42" | \$125.90 |
| 45" | \$130.05 |
| 48" | \$134.20 |

| Extrinsic Parts | | |
|-----------------|---------|---------|
| Box Only | AS | 4" DRW |
| \$95.85 | \$12.84 | \$8.90 |
| \$98.16 | \$13.83 | \$9.75 |
| \$100.48 | \$14.81 | \$10.61 |
| \$102.79 | \$15.80 | \$11.46 |
| \$105.11 | \$16.79 | \$12.31 |

Base Top Drawer / Blind Corner Right

- 1 - 4" Drawer (DRW)
- 1 - Adjustable Shelf (AS)

1 - 27" Blind Panel

Specify Single Door Cabinets as HL or HR

Doors, Drawer Fronts & Hardware Not Included In Catalog Price

BTD/BCR

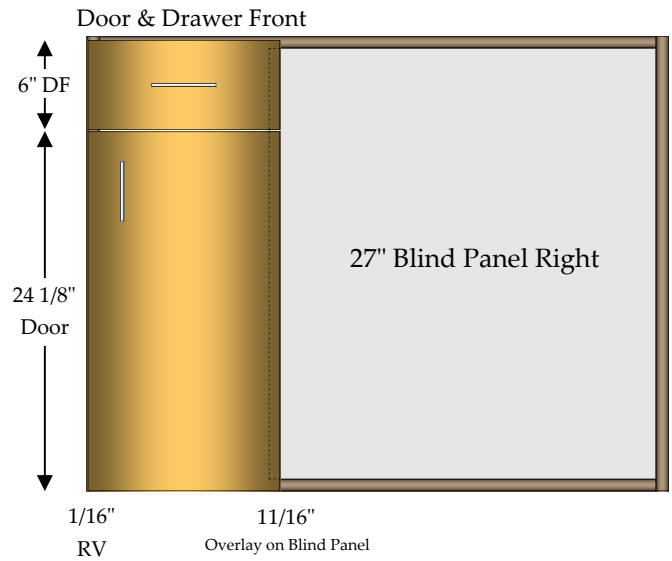
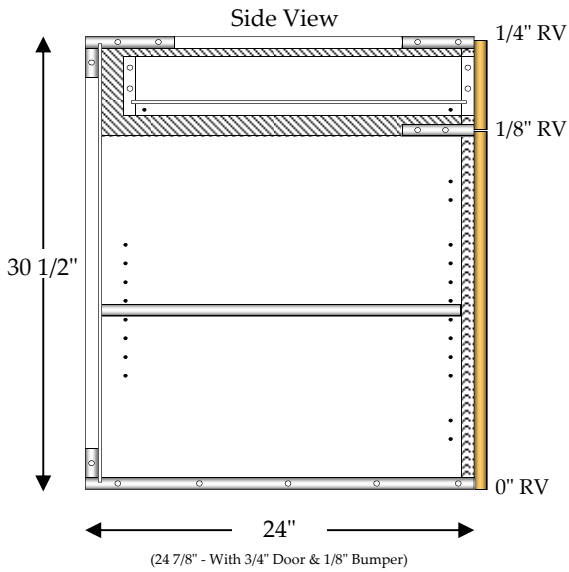

| Width | BTD/BCR |
|-------|----------|
| 36" | \$117.59 |
| 39" | \$121.74 |
| 42" | \$125.90 |
| 45" | \$130.05 |
| 48" | \$134.20 |

| Box Only | Extrinsic Parts | |
|----------|-----------------|---------|
| | AS | 4" DRW |
| \$95.85 | \$12.84 | \$8.90 |
| \$98.16 | \$13.83 | \$9.75 |
| \$100.48 | \$14.81 | \$10.61 |
| \$102.79 | \$15.80 | \$11.46 |
| \$105.11 | \$16.79 | \$12.31 |

Base Unit / Tray

3/4" Partitions (1/4" Partitions with Dado Upon Request)

Full Top

Specify Single Door Cabinets as **HL** or **HR**

Doors, Drawer Fronts & Hardware Not Included In Catalog Price

BU/Tray

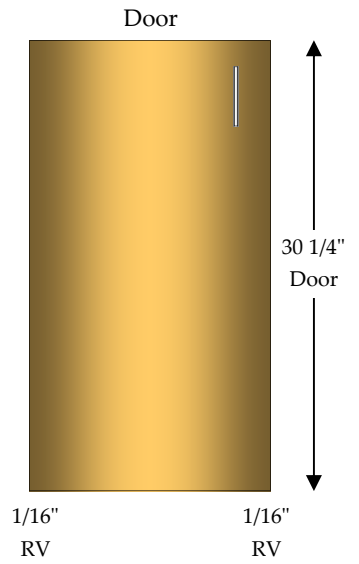
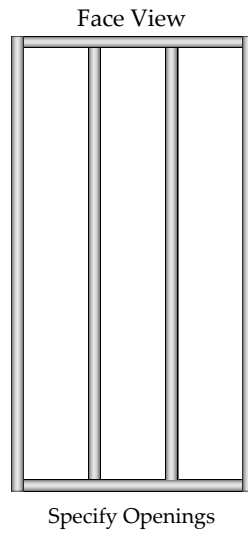
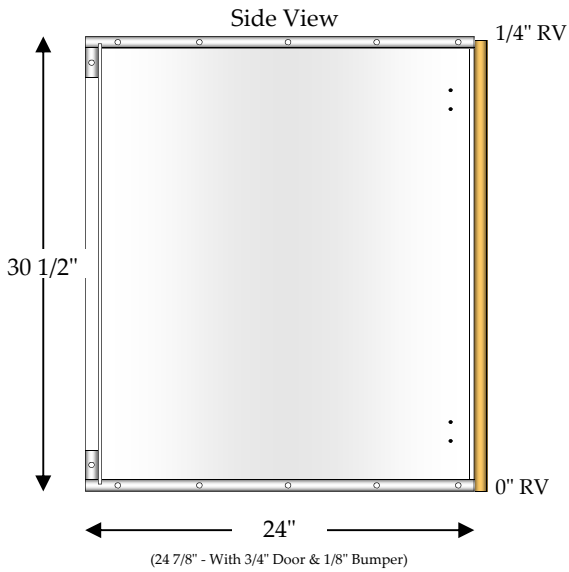

| | Width | BU/Tray |
|------|-------|---------|
| 1-PT | 9" | \$56.35 |
| 1-PT | 12" | \$58.80 |
| 2-PT | 15" | \$74.55 |
| 2-PT | 18" | \$77.00 |
| 3-PT | 21" | \$90.75 |
| 3-PT | 24" | \$93.20 |

| Box Only |
|----------|
| \$41.41 |
| \$44.07 |
| \$46.74 |
| \$49.40 |
| \$52.06 |
| \$54.72 |

Base Top Drawer / Tray

1 - 4" Drawer (DRW)

3/4" Partitions (1/4" Partitions with Dado Upon Request)

1 - Fixed Shelf (FS)

Full Top

Specify Single Door Cabinets as HL or HR

Doors, Drawer Fronts & Hardware Not Included In Catalog Price

BTD/Tray

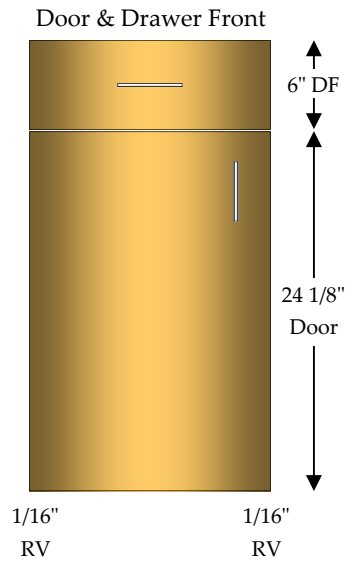
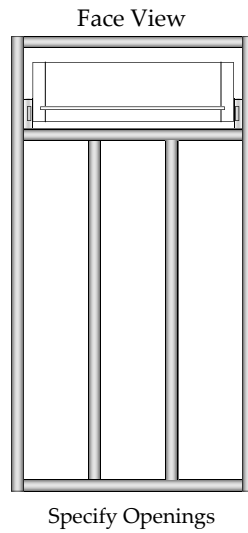
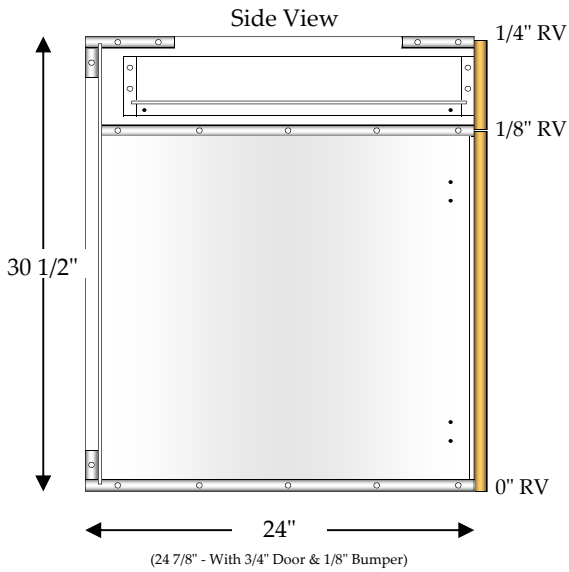

1-DRW

| | Width | BTD/Tray |
|------|-------|----------|
| 1-PT | 9" | \$76.21 |
| 1-PT | 12" | \$80.30 |
| 2-PT | 15" | \$97.01 |
| 2-PT | 18" | \$101.10 |
| 3-PT | 21" | \$115.81 |
| 3-PT | 24" | \$119.90 |

Box Only

4" DRW

| | |
|---------|---------|
| \$53.35 | \$8.90 |
| \$57.00 | \$9.75 |
| \$60.66 | \$10.61 |
| \$64.31 | \$11.46 |
| \$67.96 | \$12.31 |
| \$71.61 | \$13.16 |